

# Product data sheet

Status: 01.10.2020 | 17:38

Item no. 1240

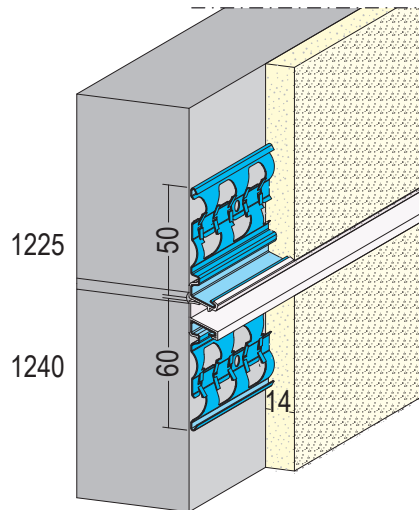

<b>Designation</b>	Sliding joint profile for exterior render 14 mm
<b>Description</b>	Sliding joint profile made of galvanised steel with PVC coating for interior and exterior plaster of 14 mm and thicker. The PVC coating protects against wear and corrosion. The sliding joint profile is comprised of lower component 1240 and the upper base profile 1225.
<b>Line of Business</b>	Plaster
<b>Productclass</b>	Exterior render
<b>Productgroup</b>	Expansion / Movement joint profiles
<b>Plaster thickness</b>	14,0 mm
<b>Material</b>	Galvanised steel, with PVC coating
<b>Standard EN</b>	EN 13658-2
<b>Product length</b>	300,0 cm
<b>Productcolor</b>	■ weiß (10)
<b>Reaction to fire (R2F)</b>	E
<b>Packaging Unit</b>	25 BAR / 40 BUN
	Apply the profiles in line with the following data sheets: *Data sheet Planning and Application of Metallic Plaster Profiles; published by: The European Association of Bead and Lath Producers, <a href="http://www.europrofiles.com">www.europrofiles.com</a> *Data sheet Plaster and Dry Construction in Damp Environments; published by: Zentralverband des Deutschen Baugewerbes, <a href="http://www.zdb.de">www.zdb.de</a> *Data sheet Winter Construction Sites; published by: Bundesverband der Gipsindustrie e.V., <a href="http://www.gips.de">www.gips.de</a> .

This product data sheet corresponds to the current state of development of our products and loses its validity upon publication of a new edition. Make sure you are using the latest edition of this information. Warranty and liability are based on delivery according to our general. Terms and conditions. Please observe the application assembly and storage guidelines.

All statements without guarantee. Reserve technical changes. Product illustrations may differ from the delivery product. Tender specifications, installation instructions and performance declarations (if required by law) can be found on our homepage. Please respect the environment for a proper disposal!

**PROTEKTORWERK**  
Florenz Maisch GmbH & Co. KG  
Postfach 1420, D-76554 Gaggenau  
Viktoriastr. 58, D-76571 Gaggenau

Tel. +49 7225 977 - 0  
Fax +49 7225 9 77 - 111  
[info@protektor.com](mailto:info@protektor.com)  
[www.protektor.com](http://www.protektor.com)

