

Product data sheet

Status: 06.12.2020 | 00:36

Item no. 1266

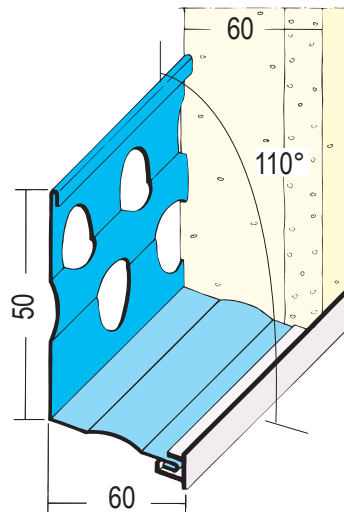

Designation	Base stop profile for insulating 60 mm
Description	Corner beads, base profiles and window lintels made of galvanised steel provide exact borders between insulation plaster surfaces. Base profiles for creating horizontal connections with an angle position of 110° for effective drip edges.
Line of Business	Plaster
Productclass	Thermal insulation rendering
Productgroup	Base rails
Plaster thickness	60,0 mm
Material	Galvanised steel, with PVC coating
Standard EN	EN 13658-2
Product length	300,0 cm
Angular Position	110°
Productcolor	■ weiß (10)
Reaction to fire (R2F)	E
Packaging Unit	15 BAR / 55 BUN

This product data sheet corresponds to the current state of development of our products and loses its validity upon publication of a new edition. Make sure you are using the latest edition of this information. Warranty and liability are based on delivery according to our general. Terms and conditions. Please observe the application assembly and storage guidelines.

All statements without guarantee. Reserve technical changes. Product illustrations may differ from the delivery product. Tender specifications, installation instructions and performance declarations (if required by law) can be found on our homepage. Please respect the environment for a proper disposal!

PROTEKTORWERK
Florenz Maisch GmbH & Co. KG
Postfach 1420, D-76554 Gaggenau
Viktoriastr. 58, D-76571 Gaggenau

Tel. +49 7225 977 - 0
Fax +49 7225 9 77 - 111
info@protektor.com
www.protektor.com

