

# Product data sheet

Status: 14.08.2020 | 11:03

Item no. 5273

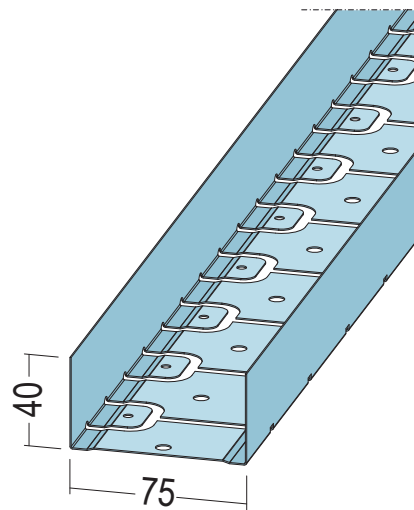

<b>Designation</b>	RS/U-track pre-slotted U 75-06
<b>Description</b>	Application area: connection profile for round walls and angled connections.
<b>Line of Business</b>	Drywall
<b>Productclass</b>	Special products
<b>Productgroup</b>	RS-Wall profiles
<b>Material</b>	Galvanised steel
<b>Galvanizing</b>	tested to standard
<b>Standard EN</b>	EN 14195
<b>Standard</b>	DIN18182-1
<b>Product length</b>	300,0 cm
<b>Product width</b>	75,0 mm
<b>Reaction to fire (R2F)</b>	A1
<b>Packaging Unit</b>	8 BAR / 15 BUN

This product data sheet corresponds to the current state of development of our products and loses its validity upon publication of a new edition. Make sure you are using the latest edition of this information. Warranty and liability are based on delivery according to our general. Terms and conditions. Please observe the application assembly and storage guidelines.

All statements without guarantee. Reserve technical changes. Product illustrations may differ from the delivery product. Tender specifications, installation instructions and performance declarations (if required by law) can be found on our homepage. Please respect the environment for a proper disposal!

**PROTEKTORWERK**  
Florenz Maisch GmbH & Co. KG  
Postfach 1420, D-76554 Gaggenau  
Viktoriastr. 58, D-76571 Gaggenau

Tel. +49 7225 977 - 0  
Fax +49 7225 9 77 - 111  
info@protektor.com  
www.protektor.com

