

Product data sheet

Status: 02.12.2020 | 10:43

Item no. 91022

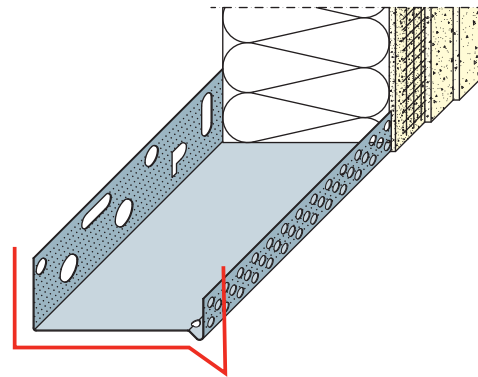
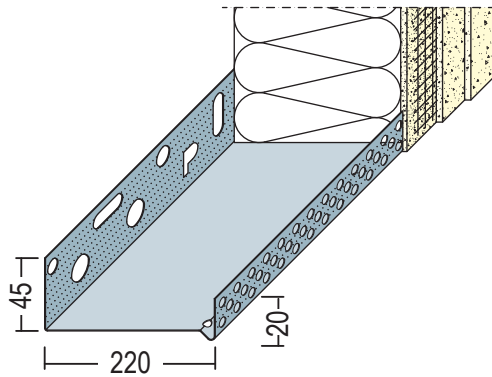

Beschichtungsseite
coated side | côté du revêtement

Designation	Base profile for thermal insulation 220 mm, Alu
Description	Aluminium base profile for thermal insulation systems.
Line of Business	Plaster
Productclass	Profiles for thermal insulation
Productgroup	Base rails
Material	Aluminum natural
Material thickness	1,0 mm
Product length	250,0 cm
Product height in mm	45,0 mm
Packaging Unit	6 BAR / 36 BUN
	Installation instructions: Insert the lower part of the combination with the fastening leg on the upper edge of the insulation panel, which runs parallel in height to joint or the plain bearing in the building body, and lightly apply the adhesive. An 8-mm thick styrofoam strip with a compliment will be applied to the base. Place the base profile on the polystyrene strip and attach to the substrate. After installing the insulation panels, hang the perforated clip-on profile. Arrange profile bars underneath one another in a staggered manner. Subdivisions and perforated attachments are designed for organic and mineral plaster constructions.

This product data sheet corresponds to the current state of development of our products and loses its validity upon publication of a new edition. Make sure you are using the latest edition of this information. Warranty and liability are based on delivery according to our general. Terms and conditions. Please observe the application assembly and storage guidelines.

All statements without guarantee. Reserve technical changes. Product illustrations may differ from the delivery product. Tender specifications, installation instructions and performance declarations (if required by law) can be found on our homepage. Please respect the environment for a proper disposal!

PROTEKTORWERK
Florenz Maisch GmbH & Co. KG
Postfach 1420, D-76554 Gaggenau
Viktoriastr. 58, D-76571 Gaggenau

Tel. +49 7225 977 - 0
Fax +49 7225 9 77 - 111
info@protektor.com
www.protektor.com

