

# Silver Plus, Silver Plus HP, and Flex Plus™ Airless Spray Guns

311254M

EN

*For the application of architectural paints and coatings. For professional use only.*

See page 3 for model information, including maximum working pressure.



### Important Safety Instructions

Read all warnings and instructions in this manual and your sprayer manual before using the equipment. Refer to your sprayer instruction manual for pressure relief, priming, and spray instructions. Save all instructions.



### Important Medical Information

Read the medical alert card provided with the gun. It contains injection injury treatment information for a doctor. Keep it with you when operating the equipment.

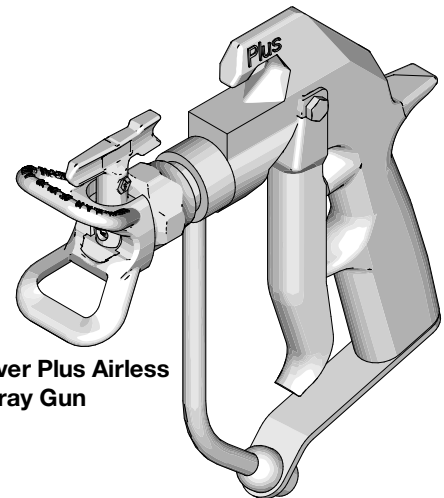

Silver Plus Airless  
Spray Gun



Flex Plus Airless  
Spray Gun



II 2 G Ex h IIA T6 Gb

# Contents

<b>Models</b> .....	<b>3</b>	<b>Parts</b> .....	<b>15</b>
<b>Warnings</b> .....	<b>4</b>	Flex Plus Spray Guns -	
<b>Component Identification</b> .....	<b>6</b>	5000 psi (345 bar, 35 MPa) .....	15
<b>Grounding</b> .....	<b>7</b>	Silver Plus Airless Spray Guns -	
<b>Pressure Relief Procedure</b> .....	<b>8</b>	5000 psi (345 bar, 35 MPa) .....	15
<b>Setup</b> .....	<b>9</b>	Parts List .....	16
Install the Tip and Guard .....	9	Silver Plus HP Airless Spray Guns -	
Connect Gun to Sprayer .....	9	7250 psi (500 bar, 50 MPa) .....	17
<b>Spray Instructions</b> .....	<b>10</b>	Parts List .....	17
Align Spray .....	10	<b>Technical Specifications</b> .....	<b>18</b>
Adjust Spray .....	10	<b>California Proposition 65</b> .....	<b>18</b>
Clear Clog .....	11	<b>Notes</b> .....	<b>19</b>
<b>Repair</b> .....	<b>12</b>	<b>Graco Standard Warranty</b> .....	<b>20</b>
Needle Replacement .....	12		
Changing Tip and Guard .....	14		



# Models

Type, Model Number, Series	Maximum Working Pressure	Trigger	Tip Guard	Tip
<b>Silver Plus 234237, A</b>	5000 psi (345 bar, 34.5 MPa)	4-finger trigger	HandTite Tip Guard	517 RAC V SwitchTip™
<b>Silver Plus, 235460, C</b>	5000 psi (345 bar, 34.5 MPa)	2-finger trigger	Standard (nonreversing) Dripless Tip Guard	No Spray Tip. Order Separately
<b>Silver Plus, 235461, B</b>	5000 psi (345 bar, 34.5 MPa)	4-finger trigger	Standard (nonreversing) Dripless Tip Guard	No Spray Tip. Order Separately. Accepts Fine finish tips only.
<b>Silver Plus, 235462, C</b>	5000 psi (345 bar, 34.5 MPa)	2-finger trigger	Standard (nonreversing) Dripless Tip Guard	No Spray Tip. Order Separately For Fine Finish
<b>Silver Plus, 235464, C</b>	5000 psi (345 bar, 34.5 MPa)	2-finger trigger	Heavy Duty RAC Tip Guard	XHD617 SwitchTip
<b>Silver Plus, 238591, A</b>	5000 psi (345 bar, 34.5 MPa)	4-finger trigger	Heavy Duty RAC Tip Guard	XHD619 SwitchTip
<b>Silver Plus, 243283, A</b>	5000 psi (345 bar, 34.5 MPa)	2-finger trigger	HandTite Tip Guard	517 RAC V SwitchTip
<b>Silver Plus, 246240, A</b>	5000 psi (345 bar, 34.5 MPa)	2-finger trigger	HandTite Tip Guard	517 RAC X SwitchTip
<b>Silver Plus, 249941, A</b>	5000 psi (345 bar, 34.5 MPa)	2-finger trigger	HandTite Tip Guard	210 RAC X Fine Finish Tip
<b>Flex Basic, 235457, C</b>	5000 psi (345 bar, 34.5 MPa)	2-finger trigger	No Tip Guard. Order Separately.	No Spray Tip. Order Separately.
<b>Flex Plus, 235458, C</b>	5000 psi (345 bar, 34.5 MPa)	2-finger trigger	Standard (nonreversing) Dripless Tip Guard	No Spray Tip. Order Separately
<b>Flex Plus, 246468, A</b>	5000 psi (345 bar, 34.5 MPa)	2-finger trigger	HandTite Tip Guard	517 RAC X SwitchTip
<b>Silver Plus, 257093, A</b>	5000 psi (345 bar, 34.5 MPa)	2-finger trigger	Heavy Duty RAC Tip Guard	XHD665 SwitchTip
<b>Silver Plus, 273329, A</b>	5000 psi (345 bar, 34.5 MPa)	2-finger trigger	Heavy Duty RAC Tip Guard	XHD519 SwitchTip
<b>Silver Plus, 273346, A</b>	5000 psi (345 bar, 34.5 MPa)	4-finger trigger	Heavy Duty RAC Tip Guard	XHD519 SwitchTip
<b>Silver Plus HP, 273334, A</b>	7250 psi (500 bar, 50 MPa)	2-finger trigger	Heavy Duty RAC Tip Guard	XHD519 SwitchTip
<b>Silver Plus HP, 273335, A</b>	7250 psi (500 bar, 50 MPa)	4-finger trigger	Heavy Duty RAC Tip Guard	XHD519 SwitchTip

# Warnings

The following warnings are for the setup, use, grounding, maintenance, and repair of this equipment. The exclamation point symbol alerts you to a general warning and the hazard symbols refer to procedure-specific risks. When these symbols appear in the body of this manual or on warning labels, refer back to these Warnings. Product-specific hazard symbols and warnings not covered in this section may appear throughout the body of this manual where applicable.

## WARNING

	<p><b>SKIN INJECTION HAZARD</b></p> <p>High-pressure fluid from gun, hose leaks, or ruptured components will pierce skin. This may look like just a cut, but it is a serious injury that can result in amputation. <b>Get immediate surgical treatment.</b></p> <ul style="list-style-type: none"> <li>• Do not spray without tip guard and trigger guard installed.</li> <li>• Engage trigger lock when not spraying.</li> <li>• Do not point gun at anyone or at any part of the body.</li> <li>• Do not put your hand over the spray tip.</li> <li>• Do not stop or deflect leaks with your hand, body, glove, or rag.</li> <li>• Follow the <b>Pressure Relief Procedure</b> when you stop spraying and before cleaning, checking, or servicing equipment.</li> <li>• Tighten all fluid connections before operating the equipment.</li> <li>• Check hoses and couplings daily. Replace worn or damaged parts immediately.</li> </ul>
	<p><b>FIRE AND EXPLOSION HAZARD</b></p> <p>Flammable fumes, such as solvent and paint fumes, in <b>work area</b> can ignite or explode. Paint or solvent flowing through the equipment can cause static sparking. To help prevent fire and explosion:</p> <ul style="list-style-type: none"> <li>• Use equipment only in well-ventilated area.</li> <li>• Eliminate all ignition sources, such as pilot lights, cigarettes, portable electric lamps, and plastic drop cloths (potential static sparking).</li> <li>• Ground all equipment in the work area. See <b>Grounding</b> instructions.</li> <li>• Never spray or flush solvent at high pressure.</li> <li>• Keep work area free of debris, including solvent, rags and gasoline.</li> <li>• Do not plug or unplug power cords, or turn power or light switches on or off when flammable fumes are present.</li> <li>• Use only grounded hoses.</li> <li>• Hold gun firmly to side of grounded pail when triggering into pail. Do not use pail liners unless they are anti-static or conductive.</li> <li>• <b>Stop operation immediately</b> if static sparking occurs or you feel a shock. Do not use equipment until you identify and correct the problem.</li> <li>• Keep a working fire extinguisher in the work area.</li> </ul>

# ! WARNING



## EQUIPMENT MISUSE HAZARD

Misuse can cause death or serious injury.



- Do not operate the unit when fatigued or under the influence of drugs or alcohol.
- Do not exceed the maximum working pressure or temperature rating of the lowest rated system component. See **Technical Specifications** in all equipment manuals.
- Use fluids and solvents that are compatible with equipment wetted parts. See **Technical Specifications** in all equipment manuals. Read fluid and solvent manufacturer's warnings. For complete information about your material, request Safety Data Sheets (SDSs) from distributor or retailer.
- Turn off all equipment and follow the **Pressure Relief Procedure** when equipment is not in use.
- Check equipment daily. Repair or replace worn or damaged parts immediately with genuine manufacturer's replacement parts only.
- Do not alter or modify equipment. Alterations or modifications may void agency approvals and create safety hazards.
- Make sure all equipment is rated and approved for the environment in which you are using it.
- Use equipment only for its intended purpose. Call your distributor for information.
- Route hoses and cables away from traffic areas, sharp edges, moving parts, and hot surfaces.
- Do not kink or over bend hoses or use hoses to pull equipment.
- Keep children and animals away from work area.
- Comply with all applicable safety regulations.



## RECOIL HAZARD

Gun may recoil when triggered. If you are not standing securely, you could fall and be seriously injured.



## PRESSURIZED ALUMINUM PARTS HAZARD

Use of fluids that are incompatible with aluminum in pressurized equipment can cause serious chemical reaction and equipment rupture. Failure to follow this warning can result in death, serious injury, or property damage.

- Do not use 1,1,1-trichloroethane, methylene chloride, other halogenated hydrocarbon solvents or fluids containing such solvents.
- Do not use chlorine bleach.
- Many other fluids may contain chemicals that can react with aluminum. Contact your material supplier for compatibility.



## TOXIC FLUID OR FUMES HAZARD

Toxic fluids or fumes can cause serious injury or death if splashed in the eyes or on skin, inhaled, or swallowed.

- Read Safety Data Sheets (SDSs) to know the specific hazards of the fluids you are using.
- Store hazardous fluid in approved containers, and dispose of it according to applicable guidelines.



## PERSONAL PROTECTIVE EQUIPMENT

Wear appropriate protective equipment when in the work area to help prevent serious injury, including eye injury, hearing loss, inhalation of toxic fumes, and burns. Protective equipment includes but is not limited to:

- Protective eyewear, and hearing protection.
- Respirators, protective clothing, and gloves as recommended by the fluid and solvent manufacturer.

# Component Identification

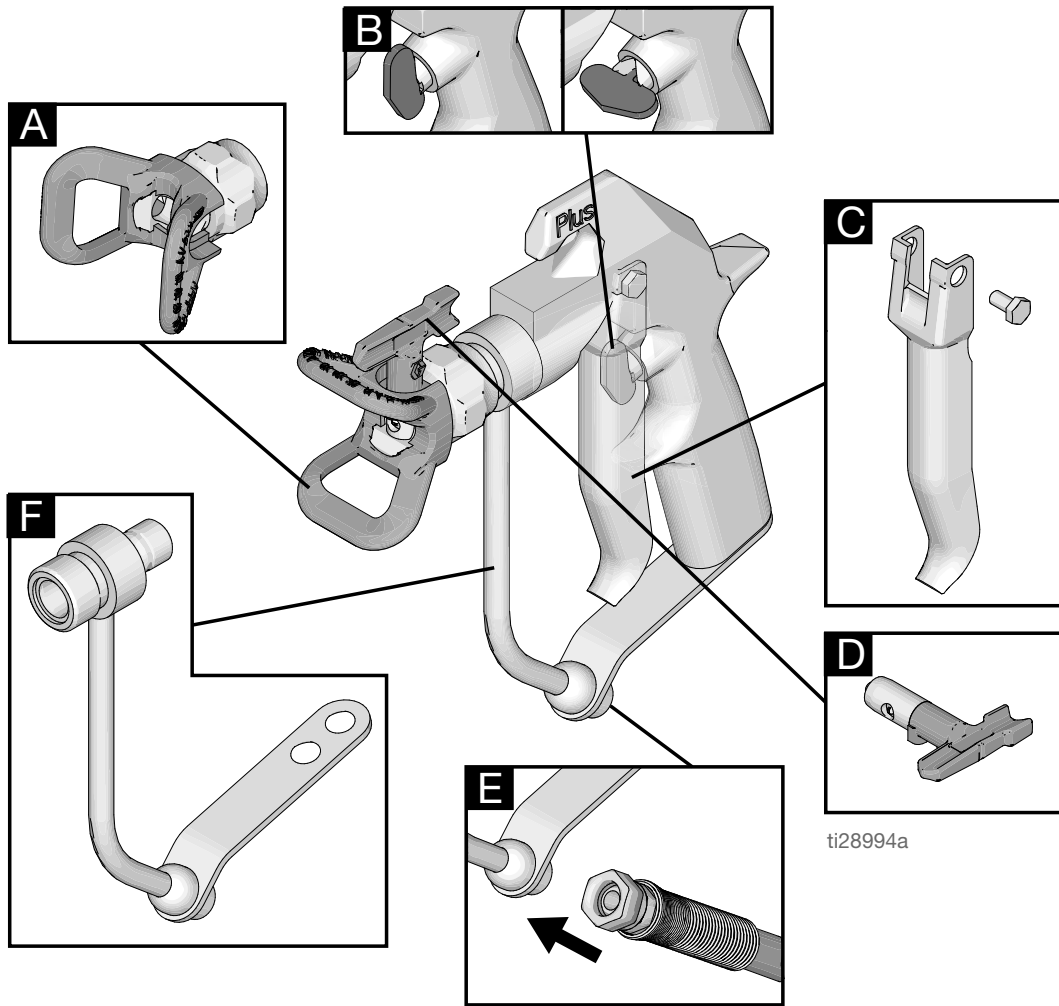

ti28994a

Ref.	Description
A	Tip Guard
B	Trigger Lock
C	Trigger
D	Tip
E	Fluid Inlet
F	Trigger Guard / Fluid Tube

# Grounding

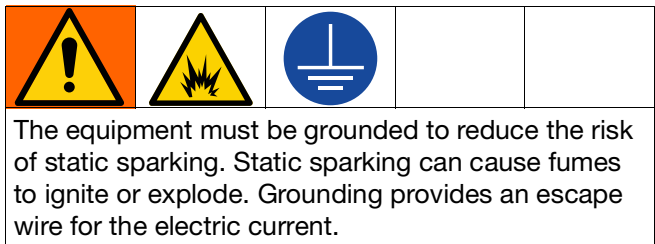

**Spray Gun:** ground through connection to a properly grounded fluid hose and pump.

**Fluid Supply Container:** follow local code.

**Solvent Pails Used when Flushing:** follow local code. Use only conductive metal pails, placed on a grounded surface. Do not place the pail on a nonconductive surface, such as paper or cardboard, which interrupts grounding continuity.

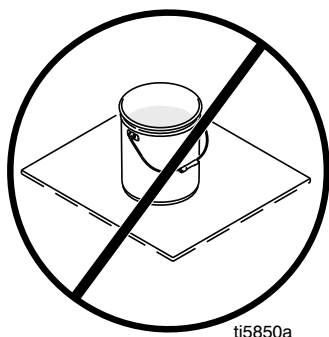

**Fluid Hose:** use only electrically conductive hoses with a maximum of 500 ft. (150 m) combined hose length to ensure grounding continuity. Check electrical resistances of hoses. If total resistance to ground exceeds 29 megohms, replace hose immediately.

**Ground Metal Pails:** Connect a ground wire to the pail by clamping one end to the pail and the other end to a ground such as a water pipe.

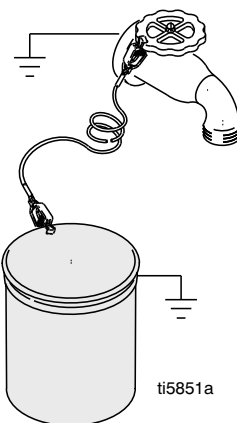

**Maintain Grounding Continuity:** When flushing or relieving pressure, hold a metal part of the gun firmly against the side of a grounded metal pail, then trigger the gun.

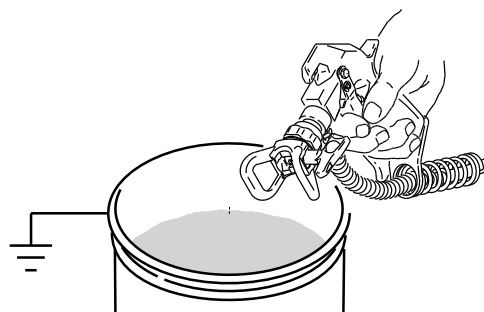

# Pressure Relief Procedure



Follow the Pressure Relief Procedure whenever you see this symbol.

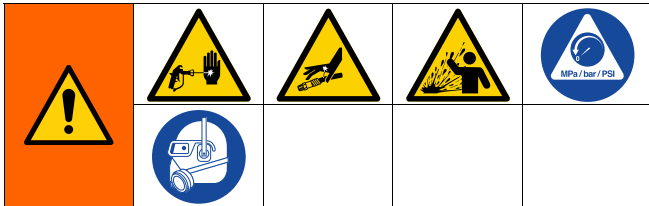

This equipment stays pressurized until pressure is manually relieved. To help prevent serious injury from pressurized fluid, such as skin injection, or splashing fluid, follow the Pressure Relief Procedure when you stop spraying and before cleaning, checking, or servicing the equipment.

1. Engage the trigger lock. Always engage the trigger lock when the sprayer is stopped to prevent the gun from being triggered accidentally.



ti6932a

2. Turn the pressure to its lowest setting. Turn the sprayer OFF and unplug the power cord or disconnect the air source from the unit.

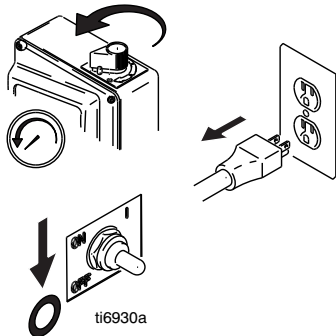

ti6930a

3. Disengage the trigger lock.



ti6933a

4. Hold a metal part of the gun firmly to a grounded metal pail. Trigger the gun to relieve pressure.

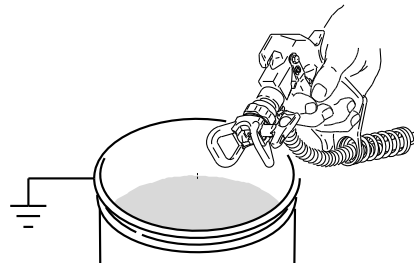

5. Engage the trigger lock.



ti6932a

6. If you suspect the spray tip or gun is clogged or that pressure has not been fully relieved:

- a. VERY SLOWLY loosen the tip guard retaining nut or the hose end coupling to relieve pressure gradually.
- b. Loosen the nut or coupling completely.
- c. Clear gun or spray tip obstructions. See **Clear Clog** on page 11.



# Setup

<p>To avoid serious injury from skin injection, do not place your hand in front of the spray tip when installing or removing the spray tip and tip guard.</p>				

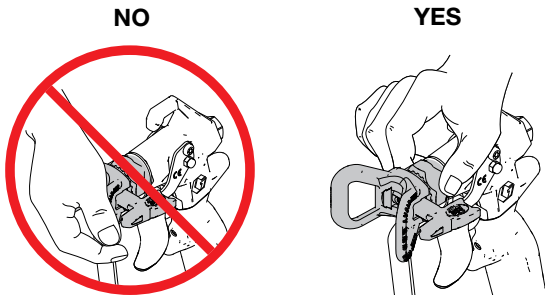

## Install the Tip and Guard

1. Engage trigger lock.



2. Follow **Pressure Relief Procedure** on page 8.
3. Always replace OneSeal™ (SL) when replacing a worn SwitchTip.

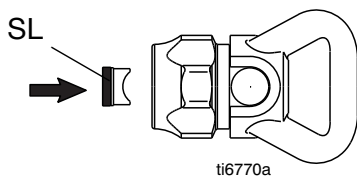

4. Use the end of SwitchTip (D) to press OneSeal (SL) into tip guard (A) with the curve matching the tip bore (TB).

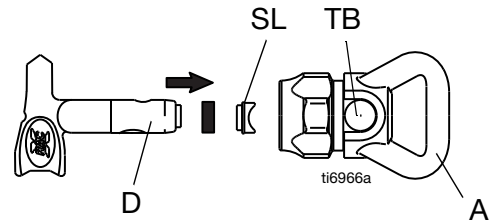

5. Insert SwitchTip (D) into tip bore. Firmly thread the assembly onto the gun, then hand tighten.

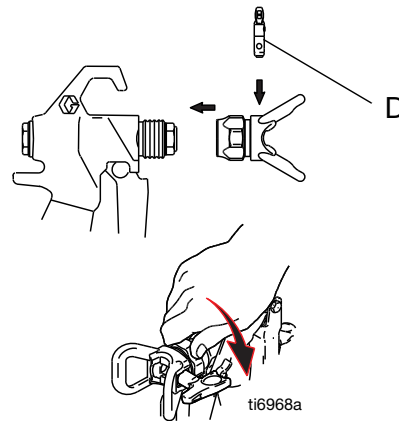

## Connect Gun to Sprayer

Make sure the sprayer is turned off and unplugged from the power source, or disconnect the air source from the unit. Refer to your sprayer manual for priming and spray instructions.

1. Attach the supply hose to the sprayer fluid outlet.
2. Refer to your sprayer instruction manual for priming instructions.

# Spray Instructions



To avoid serious injury from skin injection, do not place your hand in front of the spray tip.

## Align Spray

1. Follow the **Pressure Relief Procedure** on page 8.

**NOTE:** Turn tip guard horizontally to spray a horizontal pattern.

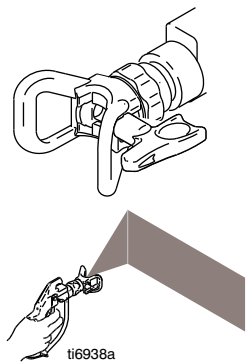

Turn tip guard vertically to spray a vertical pattern.

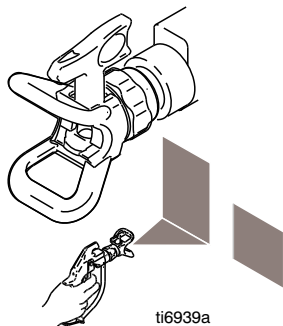

2. Before spraying, verify tip guard is tight. Tighten if necessary.

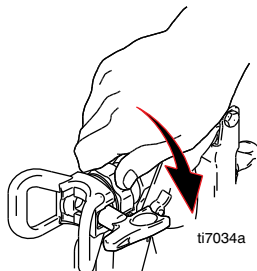

## Adjust Spray

1. Engage the trigger lock.



ti6932a

2. Install tip and guard if not already installed. See **Setup** on page 9.

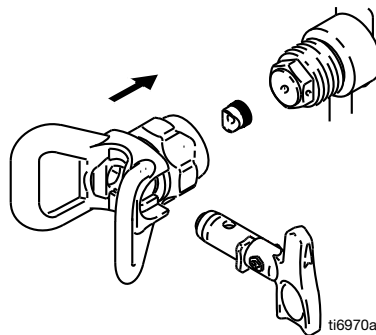

ti6970a

3. Disengage the trigger lock.



ti6933a

4. Trigger the gun.

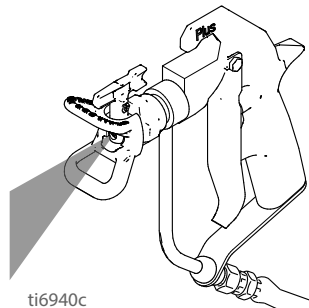

ti6940c

5. Hold the gun perpendicular and approximately 12 in. (30 cm) from the surface. Move the gun first, then pull the gun trigger to spray.

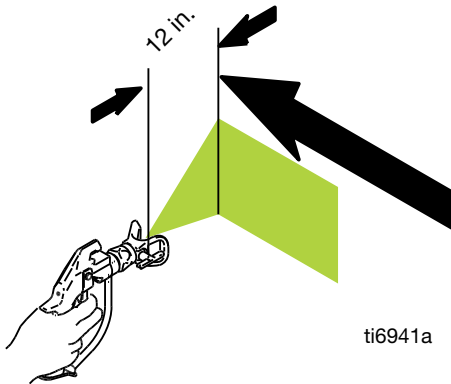

6. Slowly increase the pump pressure until coverage is even and uniform.

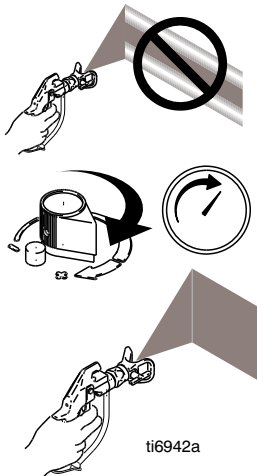

## Clear Clog

1. Engage the trigger lock.



2. Rotate the tip 180 degrees.

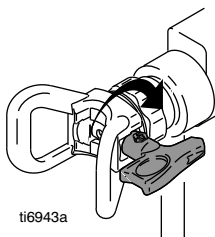

3. Disengage the trigger lock.



4. Trigger the gun into a pail to remove the clog.

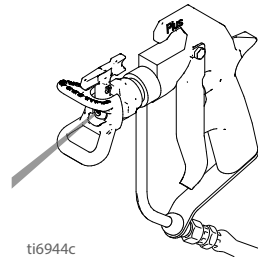

5. Engage the trigger lock.



6. Rotate the tip 180 degrees.

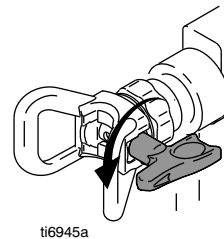

7. Disengage the trigger lock. Trigger the gun into a pail to verify the tip is clear.

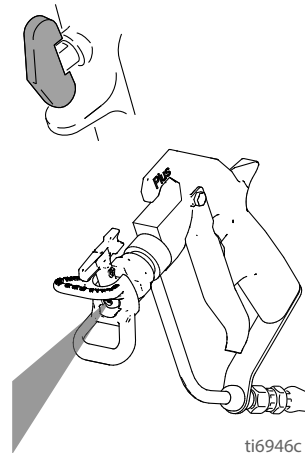

# Repair



To help prevent serious injury from pressurized fluid, follow the **Pressure Relief Procedure** before cleaning, checking, or servicing.

## Needle Replacement

1. Follow the **Pressure Relief Procedure** on page 8.
2. Engage the trigger lock.



ti6932a

3. Remove the tip and guard and disconnect the gun from the fluid hose.

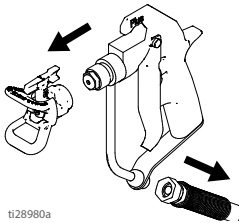

ti28980a

4. Flush the gun with cleaning fluid. See your sprayer instructions for the flushing procedure.
5. Unscrew the diffuser/seat and remove.

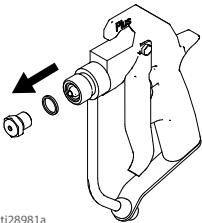

ti28981a

6. Unscrew the pivot pin from the screw and remove the trigger.

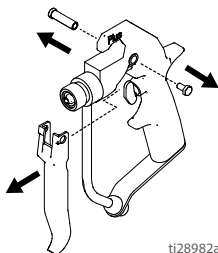

ti28982a

7. Insert a punch into the rear of the gun to tap out the needle.

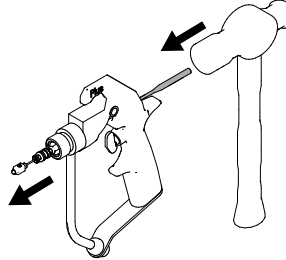

8. Clean the internal passages from the gun.

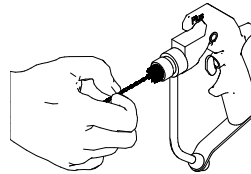

9. Grease the o-rings of the new needling using a non-silicon grease.

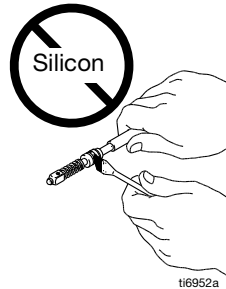

ti6952a

10. Guide the new needle into the gun.

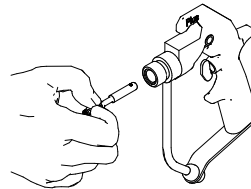

**NOTE:** An insertion tool is provided in your needle kit. This tool helps prevent damage to the needle.

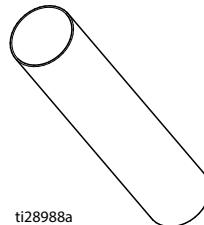

ti28988a

- 11. Position the insertion tool from the kit over one end of the needle. Tap the end of the tool using a non-sparking hammer until the needle is securely in place.

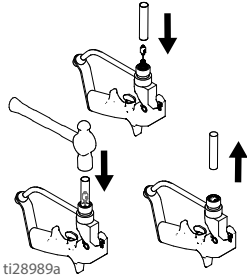

- 12. Grease the tip of the new needle.

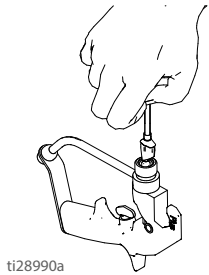

- 13. Grease the threads of the diffuser/seat. Place a gasket on the seat/diffuser.

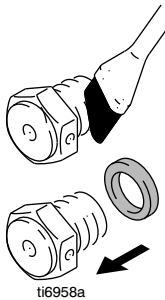

- 14. Screw the diffuser/seat onto the gun nozzle. Torque to 20-25 ft-lb (27-34 N•m). Models with a working pressure rated for 7250 psi (500 bar, 50 MPa) torque to 30-35 ft-lb (41-48 N•m).

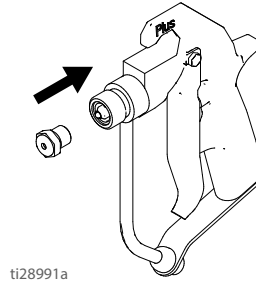

- 15. Slide the trigger into place and attach with the pivot pin and screw.

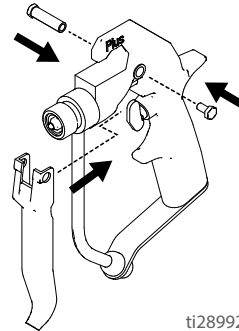

- 16. Attach the tip and guard and attach the gun to the fluid hose.

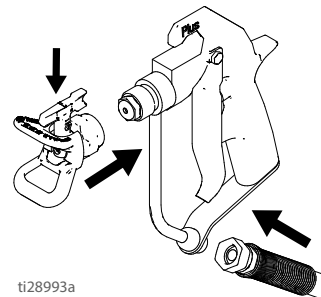

## Changing Tip and Guard

### Disassembly

1. Follow the **Pressure Relief Procedure** on page 8.
2. Unscrew the tip guard (A).

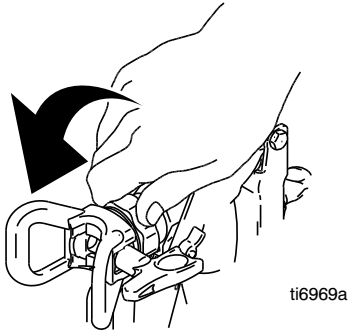

3. Use the SwitchTip (D) to remove OneSeal (SL) from the tip guard (A).

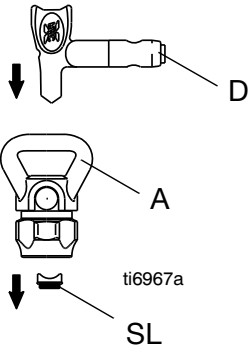

### Assembly

Install the tip and guard. See **Setup** on page 9.

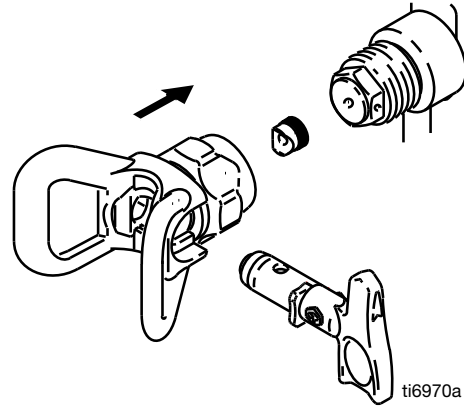

# Parts

## Flex Plus Spray Guns - 5000 psi (345 bar, 35 MPa)

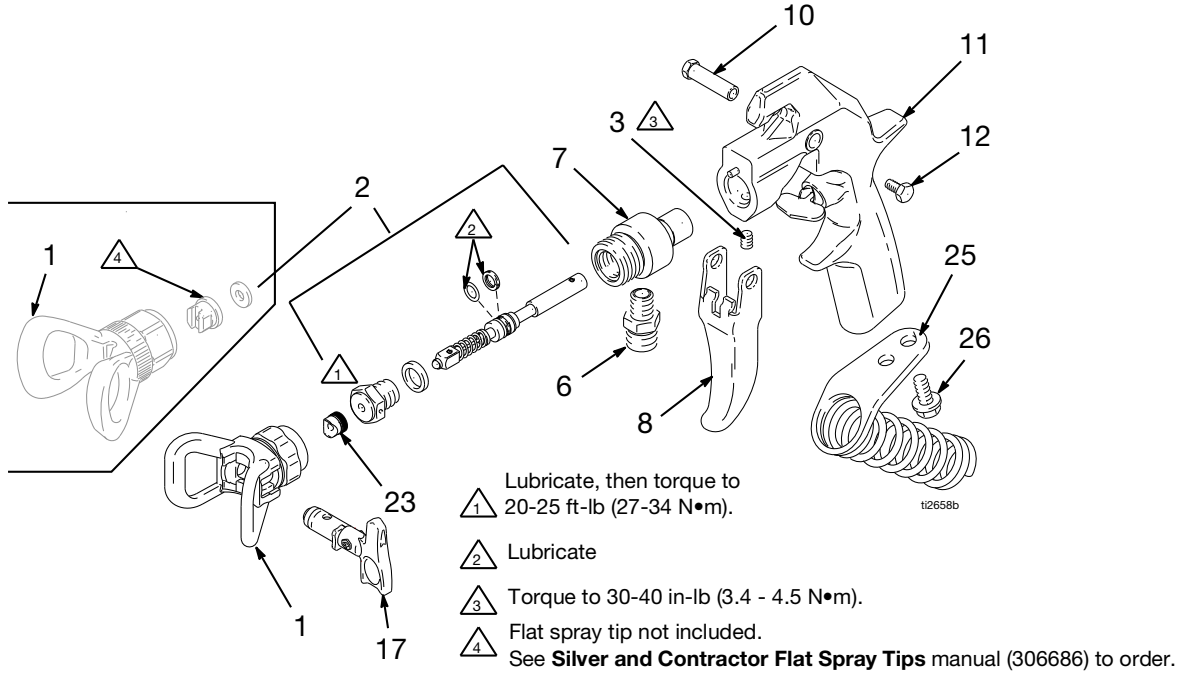

## Silver Plus Airless Spray Guns - 5000 psi (345 bar, 35 MPa)

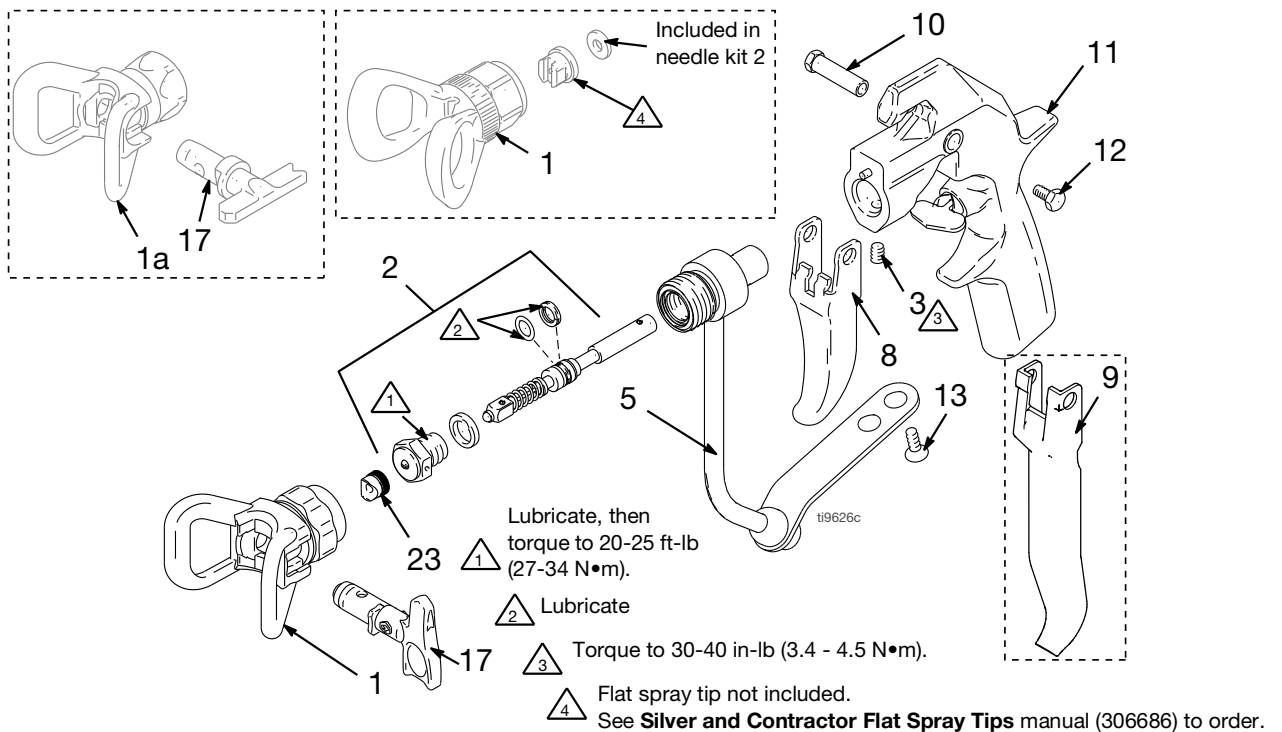

## Parts List

Ref.	Part	Description	Qty.	Ref.	Part	Description	Qty.
1	220247	TIP GUARD, fine finish, <i>model 235462 only</i>	1	13	107091	SCREW, 1/4-20	2
	220251	TIP GUARD, standard, <i>models 235458, 235460, and 235461</i>	1	15	222385	WARNING CARD <i>not shown</i>	1
	246215	HANDTITE TIP GUARD, RAC X <i>models 246240 and 246468</i>	1	17	LTX517	RAC X SwitchTip, size 517, <i>models 246240 and 246468</i>	1
	243161	HANDTITE TIP GUARD, RAC V <i>models 243283 and 234237</i>	1	XHD519	HEAVY DUTY SwitchTip, size 519, <i>models 273329 and 273346</i>		
1a	XHD001	HEAVY DUTY RAC tip assembly, <i>models 235464, 238591, and 257093, 273329, 273346</i>	1	XHD617	HEAVY DUTY SwitchTip, size 617, <i>model 235464 only</i>		1
2	235474	NEEDLE KIT, <i>all models except 235462</i>	1	XHD619	HEAVY DUTY SwitchTip, size 619, <i>model 238591 only</i>		1
	235475	NEEDLE KIT, <i>model 235462 only</i>	1	XHD665	HEAVY DUTY SWITCH TIP, size 665, <i>model 257093 only</i>		1
3	102207	SETSCREW, 1/4-20	1	286517	RAC V Switch Tip, size 517, <i>models 243283 and 234237</i>		1
5	235483	FLUID HOUSING	1	FFT210	RAC X Fine Finish Tip, <i>model 249941 only</i>		1
6	191872	ADAPTER, <i>models 235458 and 246468 only</i>	1	23	246453	OneSeal, RAC X, (5 pack), <i>models 246240 and 246468</i>	1
7	187972	FLUID HOUSING, <i>models 235458 and 246467 only</i>	1		243281	OneSeal, RAC X, (5 pack), <i>models 243283 and 234237</i>	1
8*	187985	TRIGGER, two finger	1	25	218139	HOSE HOLDER, <i>models 235458 and 246468 only</i>	1
9*	188127	TRIGGER, four finger	1	26	107257	CAPSCREW, 1/4-20 x 1/2, <i>models 235458 and 246468 only</i>	1
10	187965	PIVOT PIN	1				
11	235471	GUN HANDLE	1				
12	203953	SCREW, hex washer hd, 10-24	1				

\*See page 3 for models.



# Silver Plus HP Airless Spray Guns - 7250 psi (500 bar, 50 MPa)

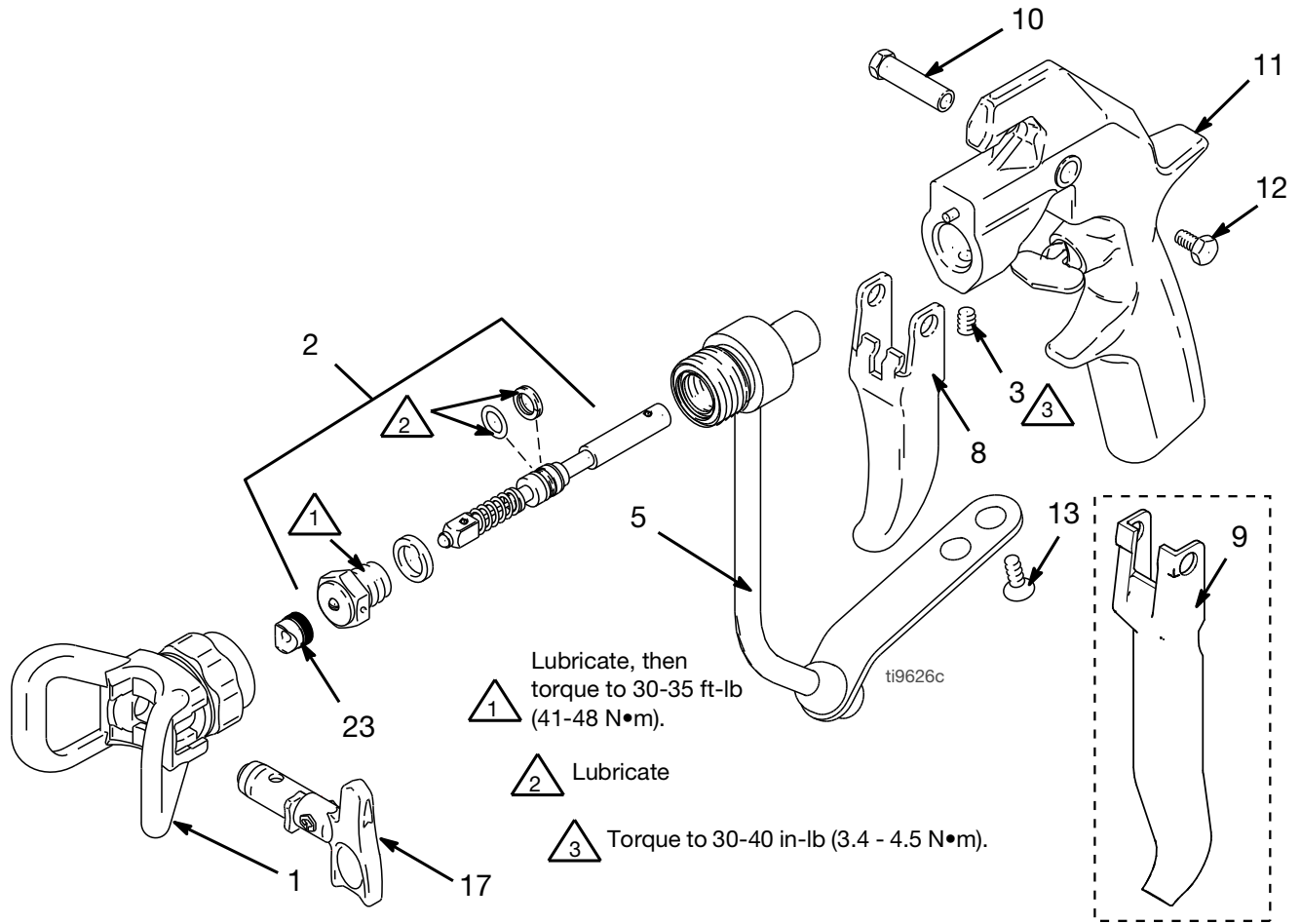

## Parts List

Ref.	Part	Description	Qty.	Ref.	Part	Description	Qty.
1	XHD001	HEAVY DUTY RAC tip assembly	1	11	20B226	GUN HANDLE	1
2	20B225	NEEDLE KIT	1	12	203953	SCREW, hex washer hd, 10-24	1
3	102207	SETSCREW, 1/4-20	1	13	107257	SCREW, 1/4-20	2
5	20B227	FLUID HOUSING	1	15	222385	WARNING CARD <i>not shown</i>	1
8*	19D983	TRIGGER, two finger	1	17	XHD519	RAC X SwitchTip, size 519	1
9*	19D985	TRIGGER, four finger	1	23	XHD010	OneSeal, RAC XHD, (5 pack)	1
10	187965	PIVOT PIN	1				

\*See page 3 for models.

# Technical Specifications

<b>Silver Plus, Silver Plus HP, and Flex Plus Airless Spray Guns</b>		
	<b>US</b>	<b>Metric</b>
Maximum working pressure	<i>See page 3 for models.</i>	
Wetted parts	Stainless steel, Polyethylene, Polyurethane, Nylon, PTFE	
Weight	18 oz	510 gram
Inlet	1/4 npsm(m)	
Maximum material temperature	120 °F	50 °C
<b>Noise (dBa)</b>		
*Sound Power	87 dB(A)	
*Sound Pressure	78 dB(A)	
<i>*Measured while spraying water-based paint, specific gravity 1.36, using a 517 tip at 3000 psi (207 bar, 20.7 MPa) per ISO-3744</i>		
<b>Notes</b>		
All trademarks or registered trademarks are the property of their respective owners.		

## California Proposition 65

### CALIFORNIA RESIDENTS

 **WARNING:** Cancer and reproductive harm – [www.P65warnings.ca.gov](http://www.P65warnings.ca.gov).



# Graco Standard Warranty

Graco warrants all equipment referenced in this document which is manufactured by Graco and bearing its name to be free from defects in material and workmanship on the date of sale to the original purchaser for use. With the exception of any special, extended, or limited warranty published by Graco, Graco will, for a period of twelve months from the date of sale, repair or replace any part of the equipment determined by Graco to be defective. This warranty applies only when the equipment is installed, operated and maintained in accordance with Graco's written recommendations.

This warranty does not cover, and Graco shall not be liable for general wear and tear, or any malfunction, damage or wear caused by faulty installation, misapplication, abrasion, corrosion, inadequate or improper maintenance, negligence, accident, tampering, or substitution of non-Graco component parts. Nor shall Graco be liable for malfunction, damage or wear caused by the incompatibility of Graco equipment with structures, accessories, equipment or materials not supplied by Graco, or the improper design, manufacture, installation, operation or maintenance of structures, accessories, equipment or materials not supplied by Graco.

This warranty is conditioned upon the prepaid return of the equipment claimed to be defective to an authorized Graco distributor for verification of the claimed defect. If the claimed defect is verified, Graco will repair or replace free of charge any defective parts. The equipment will be returned to the original purchaser transportation prepaid. If inspection of the equipment does not disclose any defect in material or workmanship, repairs will be made at a reasonable charge, which charges may include the costs of parts, labor, and transportation.

**THIS WARRANTY IS EXCLUSIVE, AND IS IN LIEU OF ANY OTHER WARRANTIES, EXPRESS OR IMPLIED, INCLUDING BUT NOT LIMITED TO WARRANTY OF MERCHANTABILITY OR WARRANTY OF FITNESS FOR A PARTICULAR PURPOSE.**

Graco's sole obligation and buyer's sole remedy for any breach of warranty shall be as set forth above. The buyer agrees that no other remedy (including, but not limited to, incidental or consequential damages for lost profits, lost sales, injury to person or property, or any other incidental or consequential loss) shall be available. Any action for breach of warranty must be brought within two (2) years of the date of sale.

**GRACO MAKES NO WARRANTY, AND DISCLAIMS ALL IMPLIED WARRANTIES OF MERCHANTABILITY AND FITNESS FOR A PARTICULAR PURPOSE, IN CONNECTION WITH ACCESSORIES, EQUIPMENT, MATERIALS OR COMPONENTS SOLD BUT NOT MANUFACTURED BY GRACO.** These items sold, but not manufactured by Graco (such as electric motors, switches, hose, etc.), are subject to the warranty, if any, of their manufacturer. Graco will provide purchaser with reasonable assistance in making any claim for breach of these warranties.

In no event will Graco be liable for indirect, incidental, special or consequential damages resulting from Graco supplying equipment hereunder, or the furnishing, performance, or use of any products or other goods sold hereto, whether due to a breach of contract, breach of warranty, the negligence of Graco, or otherwise.

## **FOR GRACO CANADA CUSTOMERS**

The Parties acknowledge that they have required that the present document, as well as all documents, notices and legal proceedings entered into, given or instituted pursuant hereto or relating directly or indirectly hereto, be drawn up in English. Les parties reconnaissent avoir convenu que la rédaction du présente document sera en Anglais, ainsi que tous documents, avis et procédures judiciaires exécutés, donnés ou intentés, à la suite de ou en rapport, directement ou indirectement, avec les procédures concernées.

# Graco Information

For the latest information about Graco products, visit [www.graco.com](http://www.graco.com).

For patent information, see [www.graco.com/patents](http://www.graco.com/patents).

**TO PLACE AN ORDER**, contact your Graco distributor or call 1-800-690-2894 to identify the nearest distributor.

*All written and visual data contained in this document reflects the latest product information available at the time of publication. Graco reserves the right to make changes at any time without notice.*

Original instructions. This manual contains English. MM

**Graco Headquarters:** Minneapolis

**International Offices:** Belgium, China, Japan, Korea

**GRACO INC. AND SUBSIDIARIES • P.O. BOX 1441 • MINNEAPOLIS MN 55440-1441 • USA**  
**Copyright 2005, Graco Inc. All Graco manufacturing locations are registered to ISO 9001.**

[www.graco.com](http://www.graco.com)  
Revision M, May 2022