

FN ACUSTICO

Inspiration & Montage



www.fnprofile.com

WE. KNOW. WOW!



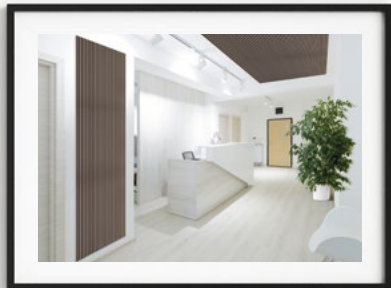
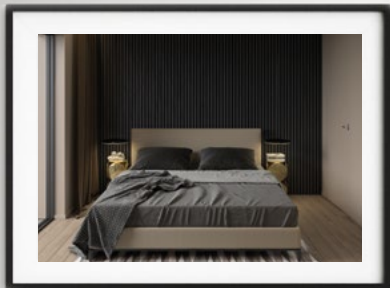

<i>FN Acustico - Infos und Fakten</i>	4
<i>Inspiration für alle Räume</i>	8
<i>Einzelleisten</i>	14
<i>Wandfliesen</i>	16
<i>Basisleiste</i>	18
<i>Montagehinweise</i>	20

www.fn-acustico.at

FN Acustico



Funktionales Design für jeden Raum

Kennen Sie den Leitsatz „Design follows function“, manchmal ironisch abgeändert in „Function follows Design“?

Bei den FN Akustikplatten folgt keines dem anderen. Hier trifft Design und Funktion auf den Punkt und wird zu einem doppelt effektvollen Gestaltungselement für jeden Raum. Und es kommt noch besser - das formschöne, funktionale Produkt ist auch noch nachhaltig.

Anwendungsbereiche

Privat

- Wohnzimmer – ideal für „Home Office“
- Garderobe und Flur
- Schlafzimmer
- Kinderzimmer
- Musikzimmer
- Esszimmer

Objektbereich

- Hotellerie/Gastronomie
- Dienstleister/Wartezimmer
- Kantinen
- Büros
- Dekorative Shopausstattung
- Schauräume
- Kundenbereiche bei Banken u. a.

PSSSSSSST!

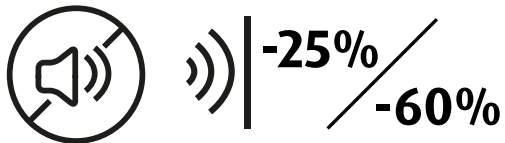

Schallschutz: Reduziert den Schall um bis zu 25%
Gewichteter Schallabsorptionskoeffizient: $\alpha_w = 0,25$
geprüft nach EN ISO 354 und EN ISO 11654.
Mit einem Unterbau von ca. 10 cm erhöht sich der
Schallschutz auf 60%: $\alpha_w = 0,60$.



Wohnen





TIPP!

Zum Kürzen in der Höhe am Besten eine Kreissäge oder einen Fuchsschwanz verwenden.



TIPP!

*Sorgt für eine angenehme
Raumakustik und schont die
Nerven Ihrer Nachbarn.*





Trennwände

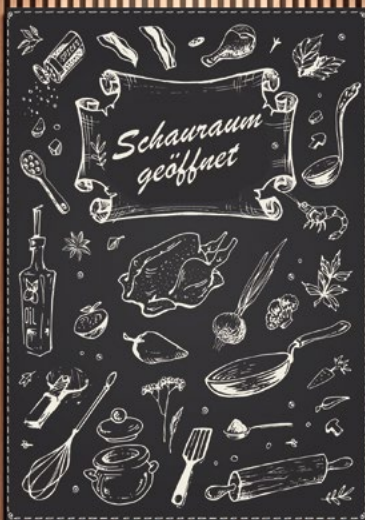



TIPP!

Als Unterbau eignet sich eine Konstruktion mit 5x5 cm Kanthölzern.

Einzelleisten



TIPP!

Mit unserem Abstandshalter haben Sie alles fest im Griff und die Montage geht wie von selbst.



TIPP!

Behelfen Sie sich hier mit einem Keil mit dem von Ihnen gewünschten Winkel.

Wandfliesen





TIPP!

Der Fantasie sind keine Grenzen gesetzt. Lassen Sie Ihrer Kreativität freien Lauf.

Basisleiste



1

2

Verlängern Sie die Akustikplatten um bis zu 20 cm

Für Raumhöhen von 250 cm und 260 cm wurden Basisleisten entwickelt, die die Montage der Paneele erleichtern, da diese direkt auf der vorher montierten Leiste aufgestellt werden.

- Vorteile:**
- **Höhenausgleich auf Raumhöhe**
 - **Leichteres Putzen im Sockelbereich**
 - **Edler Abschluss**

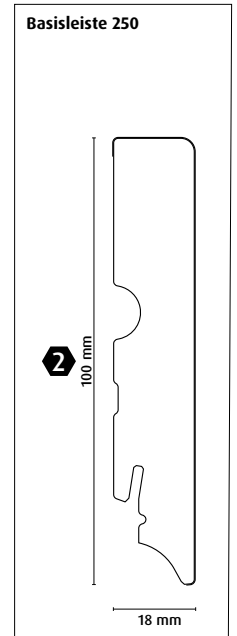
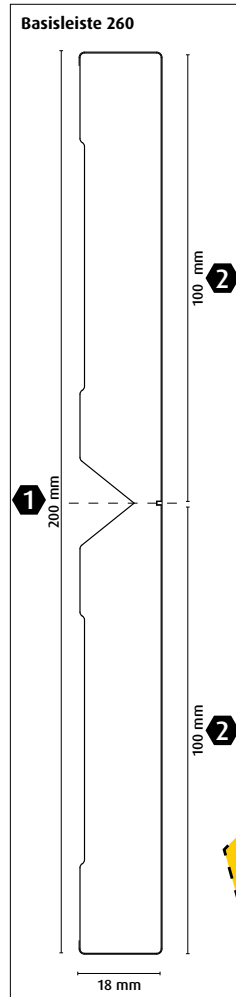
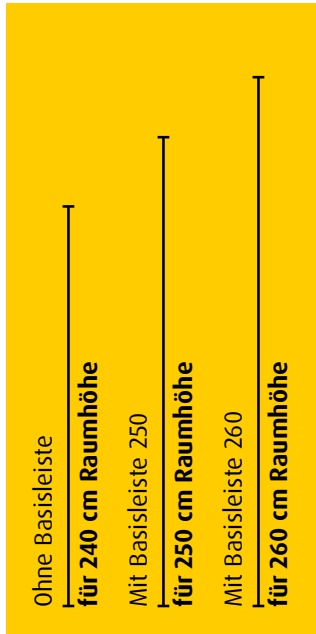

Leiste teilbar

Montage Akustikpaneel

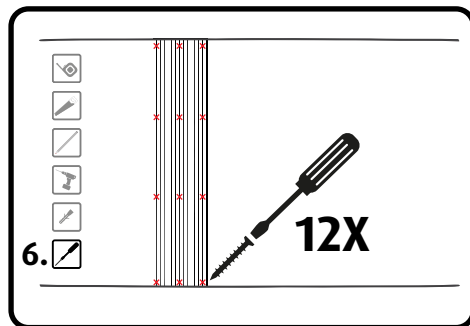
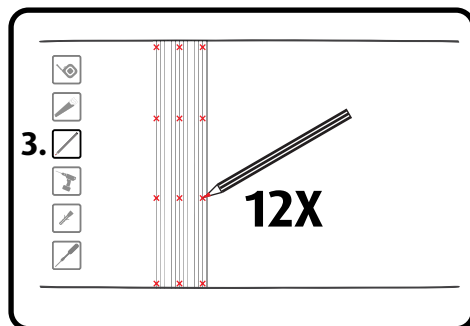
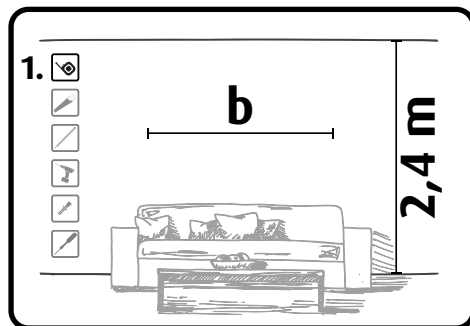

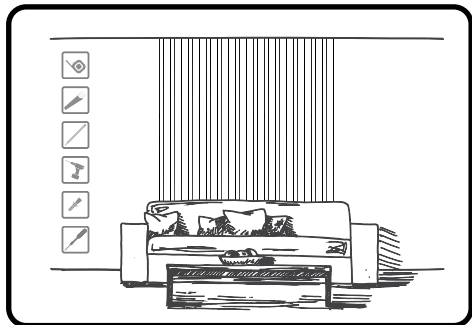
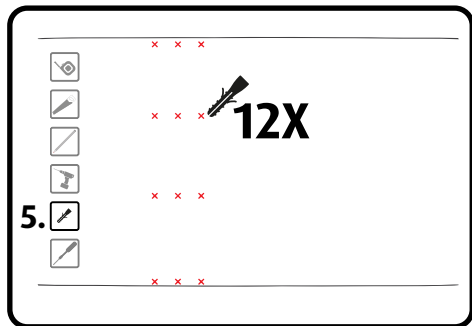
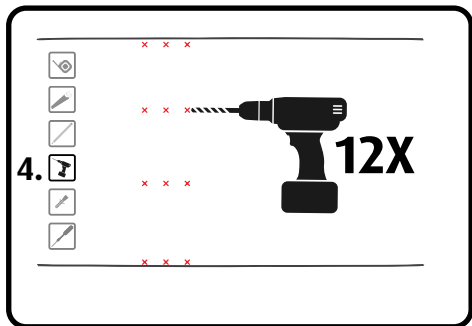
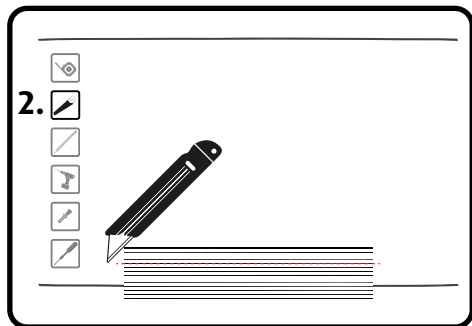
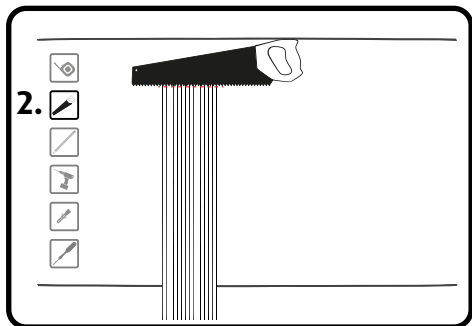

Montage Einzelleisten



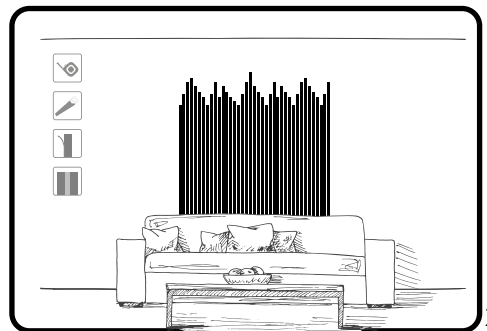
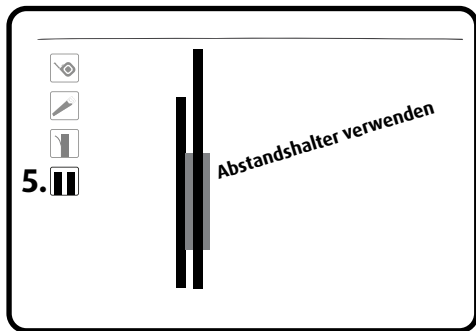
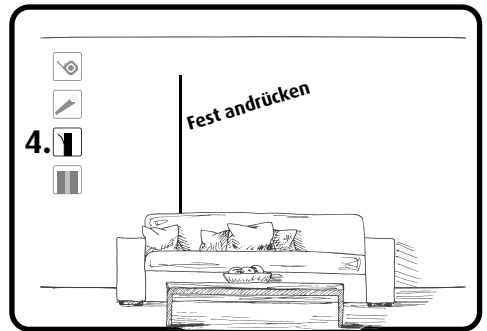
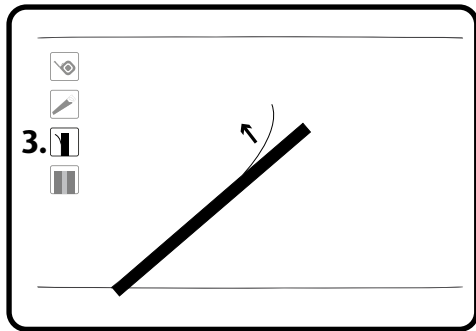
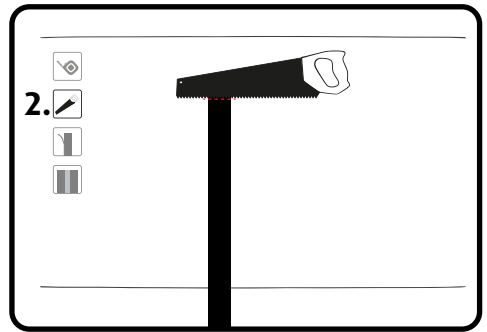
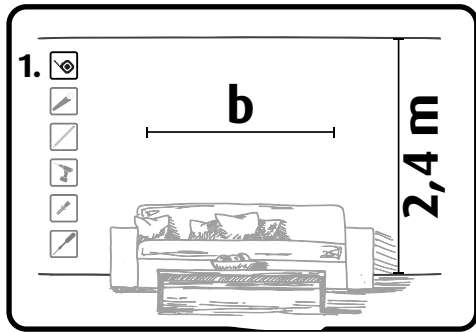

FN ACUSTICO

www.fn-acustico.at

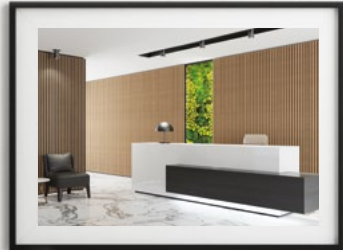
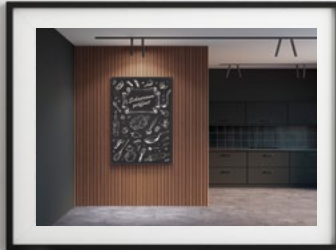
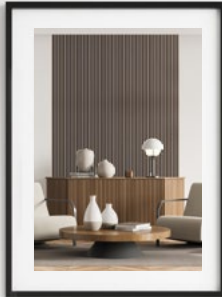
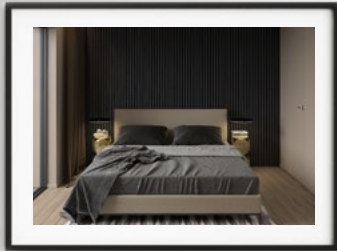

Neuhofer Holz GmbH, A-4893 Zell am Moos, Haslau 56
Tel.: +43 (0)6234/8500 - 0, Fax: +43 (0)6234/8500 - 34
office@fnprofile.com, www.fnprofile.com



certified according to ISO 9001/14001

