

Contents

Symbols used in this manual	12
Symbols on the power tool	12
Technical data	12
Overview	13
Important safety information	14
Noise and vibration	15
Instructions for use	16
Maintenance and care	20
Disposal information	20
CE Declaration of Conformity	20
UK Declaration of Conformity	20
Exemption from liability	21

Symbols used in this manual

WARNING!

Denotes impending danger. Non-observance of this warning may result in death or extremely severe injuries.

CAUTION!

Denotes a potentially dangerous situation. Non-observance of this warning may result in injury or damage to property.

NOTE!

Denotes application tips and important information.

Symbols on the power tool



Before switching on the power tool, read the operating manual!



Wear protective goggles!



Wear ear defenders!



Use lightweight breathing protection!



Disposal information for the old machine (see page 20)!

Technical data

Rechargeable hammer drill	CHE 18.0-EC	
Nominal voltage	V	18
Battery	AP 18.0 (2.5 Ah) AP 18.0 (5.0 Ah)	
No-load speed	rpm	0–1400
No-load impact rate	bpm	0–4500
Max. single impact energy (according to "EPTA procedure 05/2009")	J	1.7
Lubrication		Grease
Tool holder		SDS-plus
Max. drill diameter		
– concrete	mm	18
– wood	mm	20
– metal	mm	13
Weight according to "EPTA Procedure 01/2003" (without battery)	kg	2.0
Weight of battery 2.5 Ah	kg	0.42
5.0 Ah	kg	0.72

Overview

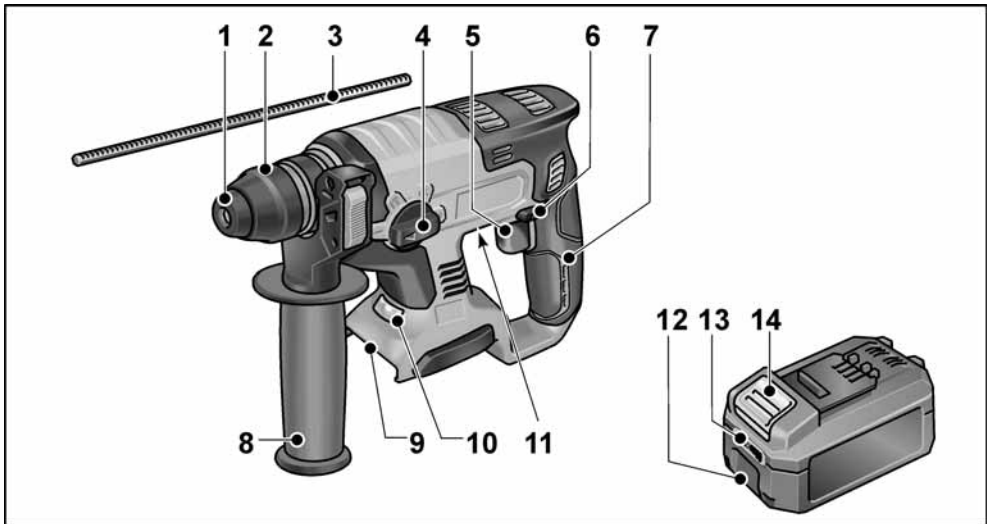

- | | | | |
|---|---------------------------------------------------------------------------------------------------|----|----------------------------------------------------|
| 1 | Dust cap | 8 | Auxiliary handle |
| 2 | Locking sleeve | 9 | Slot for battery |
| 3 | Depth stop | 10 | LED lighting
For illuminating the working area. |
| 4 | Rotary knob for operating mode | 11 | Rating plate * |
| 5 | Trigger switch
For switching on and off and for accelerating up to maximum speed/ impact rate. | 12 | Li-ion battery (2.5 Ah or 5.0 Ah) |
| 6 | Direction preselector switch | 13 | State of charge indicator |
| 7 | Handle | 14 | Release button for battery |

* (not visible)

Important safety information

WARNING!

Read all safety instructions and general instructions. Failure to comply with the safety instructions and general instructions may result in electric shock, fire and/or serious injuries. **Keep all safety instructions and general instructions in a safe place for future reference.**

Before using the power tool, please read the following and act accordingly:

- these operating instructions,
- the “General safety instructions” on the handling of power tools in the enclosed booklet (leaflet no.: 315.915),
- the currently valid site rules and the regulations for the prevention of accidents.

This power tool is state of the art and has been constructed in accordance with the acknowledged safety regulations. Nevertheless, when in use, the power tool may be a danger to life and limb of the user or a third party, or the power tool or other property may be damaged. The power tool may be operated only if it is

- for its intended use,
- in perfect working order.

Faults which compromise safety must be repaired immediately.

Intended use

The rechargeable hammer drill CHE 18.0-EC is designed

- for commercial use in industry and trade,
- for hammer drilling in masonry and concrete for wall plug and anchor attachments and through-holes,
- for light trimming work to remove plaster and tiles,
- to be used with suitable tools recommended by the manufacturer for this power tool.

Safety instructions for hammers

- **Wear ear defenders.** The effect of noise may result in loss of hearing.
- **Use auxiliary handles supplied with the power tool.** The loss of control may result in injuries.
- **Hold the power tool by the insulated gripping surfaces when performing an operation where the cutting accessory may contact hidden wiring or its own cord.** Cutting accessory contacting a “live” wire may make exposed metal parts of the power tool “live” and shock the operator.
- **Do not open the battery.** Short-circuiting hazard!
- **Protect the battery against heat, including prolonged sunshine, fire, water and moisture.** Explosion hazard!
- **A damaged or incorrectly used battery may result in the emission of fumes.** Ensure a supply of fresh air and consult a doctor in the event of any physical complications. The fumes may irritate the respiratory tracts.

Additional safety instructions

- **Use suitable detectors to detect concealed power supply cables or consult your local supply company.** Contact with electric cables may result in a fire and/or electric shock. A damaged gas pipe may cause an explosion. Cutting into a water pipe will cause damage to property or may cause an electric shock.
- **When working, hold the power tool firmly with both hands and ensure that you have a secure footing.** The power tool is controlled more securely if held with both hands.
- **Secure the workpiece.** A workpiece is held more securely in a clamping device than by hand.
- **Only use tools with SDS-plus tool holder. Pull on the tool to check that it is locked properly.**
- **Have a damaged dust cap replaced immediately.** The dust cap prevents the ingress of dust into the tool holder.

- **Dust released from materials, such as lead paints, some types of wood, minerals and metal, may be hazardous to the operator or people in the vicinity.** Inhaling or touching such dust may result in respiratory diseases and/or allergic reactions.
 - Ensure the workplace is well ventilated.
 - If possible, use external dust extraction.
 - It is recommended to wear a respirator mask belonging to filter class P2.
- Do not work on materials which release hazardous substances (e.g. asbestos).
- **Use only original batteries with the voltage indicated on the type plate of your power tool.** The use of other batteries, e.g. imitations, reconditioned batteries or other makes, increases the risk of injury and damage to property by exploding batteries.
- **Recharge batteries only with chargers recommended by the manufacturer.** A charger that is suitable for one type of battery may create a fire hazard when used with another battery.
- **The battery may be damaged by pointed objects such as e.g. nails or screwdrivers or by external application of force.** This may give rise to an internal short circuit, causing the battery to burn, smoke, explode or overheat.
- Before carrying out any work on the power tool, move the direction preselector switch to the middle position.
- Operate the direction preselector switch or torque setting turning dial only when the tool is stopped.
- Identify the power tool with stickers only. Do not drill any holes into the housing.

Noise and vibration

The noise and vibration values have been determined in accordance with EN 62841. The A-weighted noise level of the power tool is typically:

- Sound pressure level: 91 dB(A);
- Sound power level: 102 dB(A);
- Uncertainty K: 3 dB.

Total vibration value:

- when hammer drilling:
 - Emission value a_{H1} : 16 m/s²
 - Uncertainty K: 1.5 m/s²
- when chiselling:
 - Emission value a_{H1} : 10 m/s²
 - Uncertainty K: 1.5 m/s²



ATTENTION!

The indicated measurements refer to new power tools. Daily use causes the noise and vibration values to change.



NOTE!

The vibration emission level given in this information sheet has been measured in accordance with a standardised test given in EN 62841 and may be used to compare one tool with another. It may be used for a preliminary assessment of exposure. The declared vibration emission level represents the main applications of the tool. However if the tool is used for different applications, with different accessories or poorly maintained, the vibration emission may differ. This may significantly increase the exposure level over the total working period. To make an accurate estimation of the vibration exposure level, it is also necessary to take into account the times when the tool is switched off or running but not actually in use. This may significantly decrease the exposure level over the total working period. Identify additional safety measures to protect the operator from the effects of vibration such as: maintain the tool and the accessories, keep the hands warm, organisation of work patterns.



CAUTION!

Wear ear defenders at a sound pressure above 85 dB(A).

Instructions for use

Before switching on the power tool

Unpack the power tool and accessories and check that no parts are missing or damaged.

i NOTE

The batteries are not fully charged on delivery. Prior to initial operation, charge the batteries fully. Refer to the charger operating manual.

Inserting/replacing the battery

- Press the charged battery into the power tool until it clicks into place.

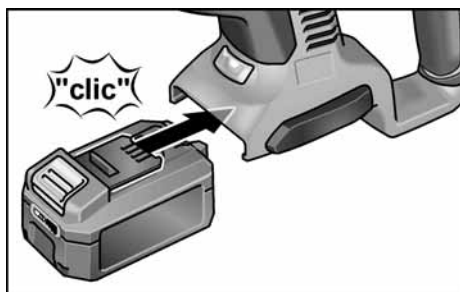

- To remove, press the release button (1.) and pull out the battery (2.).

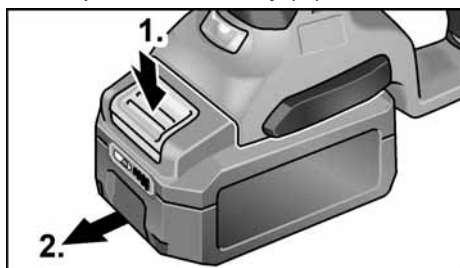

! CAUTION!

When the device is not in use, protect the battery contacts. Loose metal parts may short-circuit the contacts; explosion and fire hazard!

Battery state of charge

- Press the button to check the state of charge at the state of charge indicator LEDs.

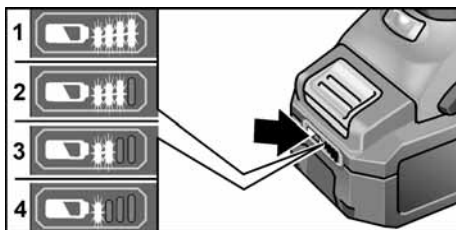

If one of the LEDs flashes, the battery must be recharged. If none of the LEDs light up after the button is pressed, the battery is faulty and must be replaced.

The indicator goes out after 5 seconds.

i NOTE

Follow the instructions for charging the battery set out in the charger operating manual.

Adjusting the auxiliary handle

! WARNING!

Remove the battery before carrying out any work on the power tool.

! CAUTION!

Use the power tool with the attached auxiliary handle only.

The auxiliary handle can be swivelled into any position to ensure safe and fatigue-free working.

i NOTE!

With the depth stop attached, the pivot range of the auxiliary handle is restricted.

- Release the clamping by turning the auxiliary handle counterclockwise (1.).

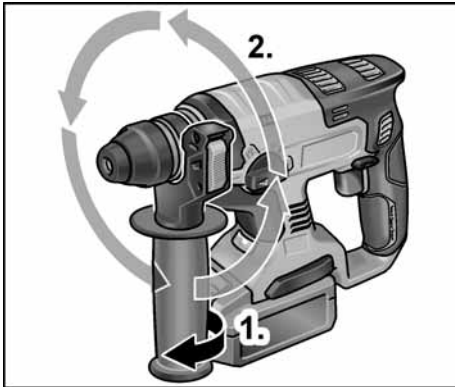

- Swivel the auxiliary handle into the desired position (2.).
- Secure the adjustment by turning the auxiliary handle clockwise.

Attaching the depth stop

⚠ WARNING!

Remove the battery before carrying out any work on the power tool.

- Press and hold clamping lever on auxiliary handle in upper area (1.).

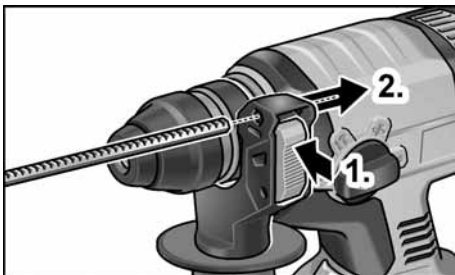

- Push in the depth stop (2.).
- Set depth stop to the required drilling depth.
- Release clamping lever.

i NOTE!

Push tool with SDS-plus shank in the SDS-plus tool holder as far as the back position. The movement of the tool could otherwise result in an incorrect drilling depth setting.

Inserting tools with SDS-plus shank

⚠ WARNING!

Remove the battery before carrying out any work on the power tool.

⚠ CAUTION!

Used cutting accessories may become hot. Wear protective gloves!

i NOTE!

Tools used must have an SDS-plus shank. If tools do not have an SDS-plus shank (e.g. wood drill bit), a three-jaw chuck must be used (see "Fitting the three-jaw chuck").

- Check the dust cap.
 - Clean the cap if dirty.
 - Have a defective dust cap replaced.
- Clean tools and lightly grease the shank.

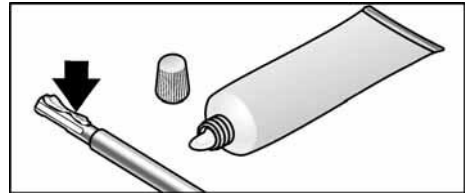

- Insert the cutting accessory (1.) and turn (2.) until it locks.

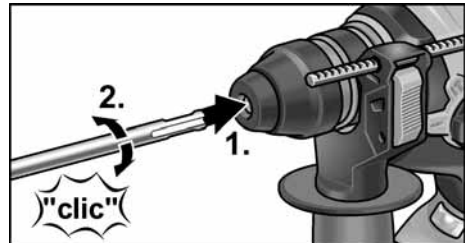

- Check lock by pulling on the cutting accessory.

Removing the accessories

⚠ WARNING!

Remove the battery before carrying out any work on the power tool.

⚠ CAUTION!

Used cutting accessories may become hot. Wear protective gloves!

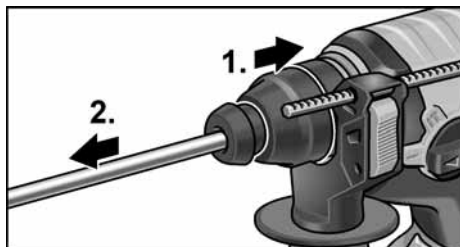

- Pull the locking sleeve backwards (1.).
- Remove the cutting accessory (2.).

Fitting the three-jaw chuck

i NOTE!

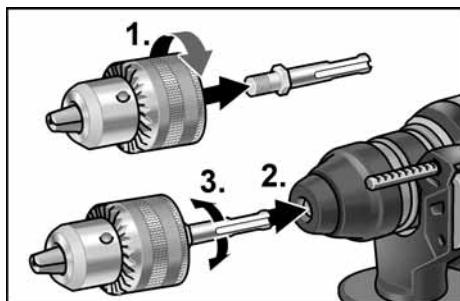

To fit a three-jaw chuck you will need the original adapter from the FLEX accessories range.

- Screw the three-jaw chuck onto the adapter (1.).



- Insert the adapter (2.) and turn (3.) until it locks.
- Check the lock by pulling on the three-jaw chuck.

⚠ CAUTION!

With the three-jaw chuck fitted, never use chiselling mode  or hammer drill mode ! The tool and three-jaw chuck could become damaged.

Direction preselection

⚠ CAUTION!

Change the direction of rotation only when the power tool is stopped.

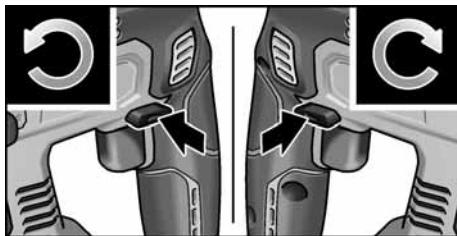

- Move the direction preselector switch to the required position:
 - **Left:** counterclockwise (remove screws, release screws)
 - **Right:** clockwise (drill, insert screws, tighten down screws)
 - **Middle:** switch-on interlock (tool change, when working on the power tool)



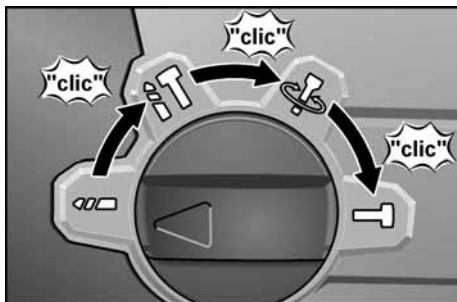

Setting the operating mode

⚠ CAUTION!

Do not change the operating mode until the power tool has come to a stop.



- Setting rotary knob to the required operating mode:

-  Drilling
-  Hammer drilling
-  Setting the chisel position (see below)
-  Chiselling

i NOTE!

- The rotary knob must audibly click into place in all positions.
- Do not switch on the power tool in the  position (setting the chisel position).

Setting the chisel position

The chisel can be turned to a position which is ideal for the work to be performed.

- Move the operating mode rotary knob to the  symbol (1.).
- Turn the chisel until it is at the required angle (2.).

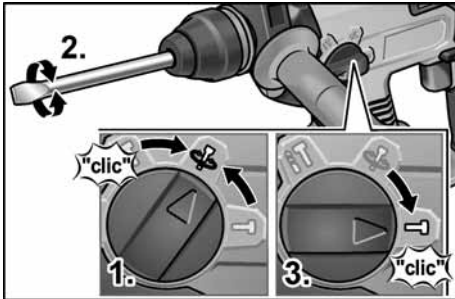

- Move the operating mode rotary knob to the  symbol (3.). Make sure it audibly clicks into place.

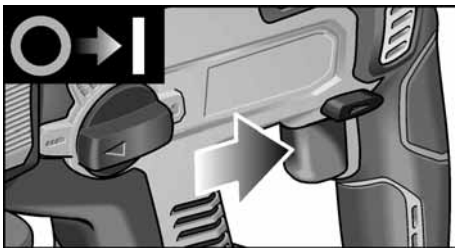
Switching on the power tool



- Press and hold down the trigger switch. The power tool trigger switch enables the speed or impact rate to be increased slowly to the maximum value.

The LED illuminates the working area when the power tool is switched on.

To switch off the machine:

- Release the trigger switch.



Operating instructions**Drilling/hammer drilling**

1. Move the operating mode rotary knob to the  (drilling) or  (hammer drilling) symbol. Make sure it audibly clicks into place.
2. Insert the drill bit.
3. Swivel the auxiliary handle into the required position.
4. Insert the battery.
5. Grip the power tool with both hands and assume the working position.



6. Position the drill bit and switch on the power tool.
7. Gently press the power tool forwards.
8. After drilling, switch off the power tool.

Chiselling

1. Insert the chisel.
2. Move the operating mode rotary knob to the  symbol.
3. Turn the chisel into the required position.
4. Move the operating mode rotary knob to the  symbol. Make sure it audibly clicks into place.
5. Swivel the auxiliary handle into the required position.
6. Insert the battery.
7. Grip the power tool with both hands and assume the working position.
8. Switch on the power tool.
9. When chiselling, gently press the power tool forwards to prevent it from jumping.
10. After working, switch off the power tool.

Other information

- The use of “sharp” cutting accessories increases performance and the service life of the power tool.
- After work, clean the power tool and store in the carrying case in a dry location.

Maintenance and care

WARNING!

Remove the battery before carrying out any work on the power tool.

Cleaning

Regularly clean the power tool and ventilation slots. Frequency of cleaning is dependent on the material and duration of use. Regularly blow out the housing interior and motor with dry compressed air.

Repairs

Repairs may be carried out by an authorised customer service centre only.

Spare parts and accessories

Other accessories, in particular cutting accessories, can be found in the manufacturer's catalogues.

Exploded drawings and spare-part lists can be found on our homepage:

www.flex-tools.com

Disposal information

WARNING!

Render disused power tools unusable by removing the power cord.



EU countries only.

Do not dispose of electric power tools in the household waste!

In accordance with the European Directive 2012/19/EU on Waste Electrical and Electronic Equipment and its incorporation into national law, used power tools must be collected separately and recycled in an environmentally friendly manner.



Raw material recovery instead of waste disposal.

Device, accessories and packaging should be recycled in an environmentally friendly manner. Plastic parts are identified for recycling according to material type.

WARNING!

Do not throw batteries into the household waste, fire or water. Do not open used batteries.

EU countries only:

In accordance with Directive 2006/66/EC defective or used batteries must be recycled.



NOTE!

Please ask your dealer about disposal options.

CE Declaration of Conformity

We declare on our sole responsibility that the product described in "Technical specifications" conforms to the following standards or normative documents:

EN 62841 in accordance with the regulations of the directives 2014/30/EU, 2006/42/EC, 2011/65/EU.

Responsible for technical documents:

FLEX-Elektrowerkzeuge GmbH, R & D
Bahnhofstrasse 15, D-71711 Steinheim/Murr

Peter Lameli
Technical Head

Klaus Peter Weiper
Head of Quality
Department (QD)

15.12.2020

FLEX-Elektrowerkzeuge GmbH
Bahnhofstrasse 15, D-71711 Steinheim/Murr



UK Declaration of Conformity

We as the manufacturer: **FLEX Elektrowerkzeuge GmbH**,

Business address: **Bahnhofstr. 15, 71711 Steinheim, Germany**

declare under our sole responsibility, that the product(s) described under "Technical specifications" fulfills all the relevant provisions of **The Supply of Machinery (Safety) Regulations S.I. 2008/1597** and also fulfills all the relevant provisions of the following UK Regulations:

Electromagnetic Compatibility Regulations S.I. 2016/1091, The Restriction of the Use of Certain Hazardous Substances in Electrical and Electronic Equipment

Regulations S.I. 2012/3032 and are manufactured in accordance with the following designated Standards:

BS EN 62841-1:2015, BS EN 62841-2-6:2020, BS EN 55014-1:2017, BS EN 55014-2:2015

Place of declaration: **Steinheim, Germany.**

Responsible person: **Peter Lameli, Technical Director - FLEX-Elektrowerkzeuge GmbH**

Contact details for Great Britain: FLEX Power Tools Limited, Unit 8 Anglo Office Park, Lincoln Road, HP 12, 3RH Buckinghamshire, United Kingdom.



Peter Lameli
Technical Head

Klaus Peter Weinper
Head of Quality
Department (QD)

19.05.2021

Exemption from liability

The manufacturer and his representative are not liable for any damage and lost profits due to interruption in business caused by the product or by an unusable product.

The manufacturer and his representative are not liable for any damage which was caused by improper use of the power tool or by use of the power tool with products from other manufacturers.