

## Contents

Symbols used in this manual	14
Symbols on the power tool	14
Technical data	14
Overview	15
Important safety information	16
Noise and vibration	17
Instructions for use	18
Maintenance and care	22
Disposal information	23
CE conformity	23
Exemption from liability	23

## Symbols used in this manual

### **WARNING!**

*Denotes impending danger. Non-observance of this warning may result in death or extremely severe injuries.*

### **CAUTION!**

*Denotes a potentially dangerous situation. Non-observance of this warning may result in slight injury or damage to property.*

### **NOTE**

*Denotes application tips and important information.*

## Symbols on the power tool



Before switching on the power tool, read the operating manual!



Wear protective goggles!



Wear ear defenders!



Disposal information for the old machine (see page 23)!

## Technical data

RSP DW 18.0-EC		
Machine type	Cordless sabre saw	
Nominal voltage	V	18
Battery	AP 18.0 (2.5 Ah) AP 18.0 (5.0 Ah)	
Stroke rate, no load	rpm	0-3000
Stroke	mm	32
Max. material thickness	mm	20
– metal	mm	230
– wood		
Weight according to „EPTA-procedure 01/2003“ (without battery)	kg	4.15
Weight of battery	kg	0.42
– AP 18.0/2.5 Ah	kg	0.72
– AP 18.0/5.0 Ah		

## Overview

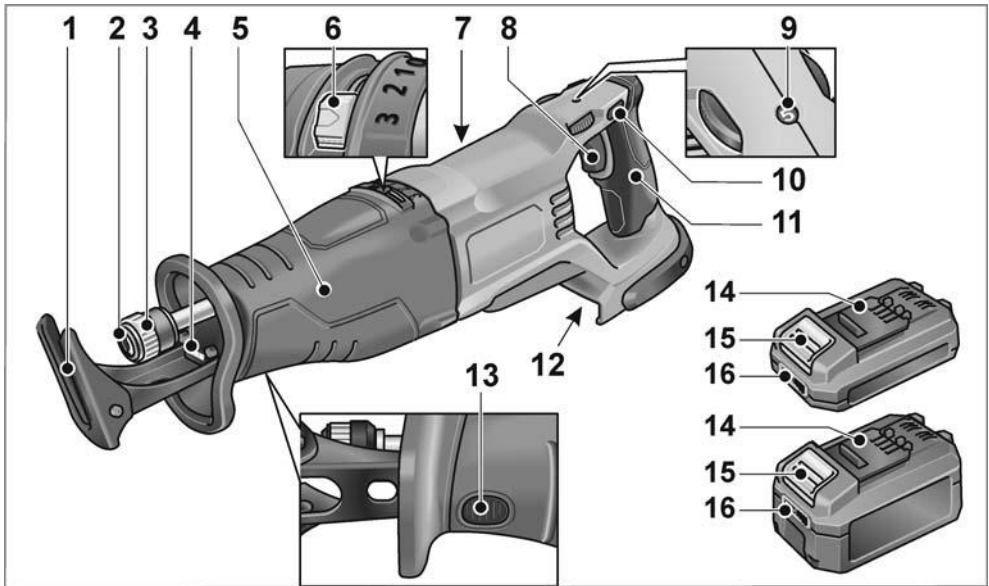

- |   |  |    |  |
|---|--|----|--|
| 1 | <b>Cutting support</b>   | 9  | <b>Stroke number control</b>             |
| 2 | <b>Tool holder</b>   | 10 | <b>Switch-on interlock</b>               |
| 3 | <b>Tool holder lock</b>  | 11 | <b>Rear handle</b>                       |
| 4 | <b>LED lighting</b><br>For illuminating the working area.  | 12 | <b>Slot for battery</b>                  |
| 5 | <b>Front handle</b>  | 13 | <b>Cutting support lock</b>              |
| 6 | <b>Pendulum stroke switch</b>  | 14 | <b>Li-ion battery (2.5 Ah or 5.0 Ah)</b> |
| 7 | <b>Rating plate *</b>  | 15 | <b>Release button for battery</b>        |
| 8 | <b>ON/OFF switch</b><br>For switching on and off and for accelerating up to maximum stroke rate. | 16 | <b>State of charge indicator</b>         |

\* (not visible)

## Important safety information

### **WARNING!**

Before using the power tool, please read and follow:

- these operating instructions,
- the “General safety instructions” on the handling of power tools in the enclosed booklet (leaflet no.: 315.915),
- the currently valid site rules and the regulations for the prevention of accidents.

*This power tool is state of the art and has been constructed in accordance with the acknowledged safety regulations. Nevertheless, when in use, the power tool may be a danger to life and limb of the user or a third party, or the power tool or other property may be damaged. The power tool may be operated only if it is*

- for its intended use,
- in perfect working order.

*Faults which compromise safety must be repaired immediately.*

### Intended use

The sabre saw is intended

- for commercial use in industry and trade,
- for sawing metal, plastic and wood,
- for sawing tiles and ceramics,
- for straight and curved cuts,
- for cutting pipes,
- to be used with suitable tools recommended by the manufacturer for this power tool.

### Safety instructions for sabre saws

#### **WARNING!**

*Read all safety instructions and general instructions. Failure to comply with the safety instructions and general instructions may result in electric shock, fire and/or serious injuries. Save all warnings and instructions for future reference.*

- **Hold the power tool by the insulated gripping surfaces when performing an operation where the tool attachment may contact hidden power leads.** Cutting accessory contacting a “live” wire may make exposed metal parts of the power tool “live” and could give the operator an electric shock.

- **Keep hands away from the sawing area. Do not grip under the workpiece.** Risk of injury if contact is made with the saw blade!
- **Guide the power tool only when it is switched on against the workpiece.** Otherwise there is the risk of kickback if the cutting accessory snags in the workpiece.
- **Make sure the cutting support always rests on the workpiece when sawing.** The saw blade may snag, causing the operator to lose control of the power tool.
- **After completing the cutting operation, switch off the power tool and withdraw the saw blade from the cut only after the blade has come to a complete stop.** In this way, you will avoid any kickback and you can now safely put the power tool down.
- **Use only undamaged saw blades that are in perfect condition.** Bent or blunt saw blades may break or cause a kickback.
- **After switching off, do not attempt to brake the saw blade by applying lateral counterpressure.** The saw blade may incur damage, break or cause a kickback.
- **Clamp the material so that it is firmly secured. Do not support the workpiece with your hand or foot.** Do not touch any objects or the ground with the saw while it is running. Risk of kickback!
- **Use suitable detectors to detect concealed power supply cables or consult your local supply company.** Contact with electric cables may result in a fire and/or electric shock. A damaged gas pipe may cause an explosion. Cutting into a water pipe will cause damage to property or may cause an electric shock.
- **When working, hold the power tool firmly with both hands and ensure that you have a secure footing.** The power tool is controlled more securely if held with both hands.
- **Keep the workplace clean. Material mixtures are especially dangerous.** Light metal dust may burn or explode.
- **Wait until the power tool has come to a stop before putting it down.** The cutting accessory may snag, causing the operator to lose control of the power tool.
- **Secure the workpiece.** A workpiece is held more securely in a clamping device than by hand.

## Special safety instructions

- Do not work on materials which release hazardous substances (e.g. asbestos).
- Identify the power tool with stickers only. Do not drill any holes into the housing.

## Noise and vibration

The noise and vibration values have been determined in accordance with EN 62841. The A-weighted noise level of the power tool is typically:

- Sound pressure level: 88 dB(A);
- Sound power level: 99 dB(A);
- Uncertainty K: 3 dB.

Total vibration value when sawing wood:

- Emission value  $a_h$   
when sawing chipboard: 9.1 m/s<sup>2</sup>
- Emission value  $a_h$   
when sawing wooden beam: 12.1 m/s<sup>2</sup>
- Uncertainty K: 1.5 m/s<sup>2</sup>

### **ATTENTION!**

*The indicated measurements refer to new power tools. Daily use causes the noise and vibration values to change.*

### **NOTE**

The vibration emission level given in this information sheet has been measured in accordance with a standardised test given in EN 62841 and may be used to compare one tool with another. It may be used for a preliminary assessment of exposure.

The declared vibration emission level represents the main applications of the tool. However if the tool is used for different applications, with different accessories or poorly maintained, the vibration emission may differ. This may significantly increase the exposure level over the total working period. To make an accurate estimation of the vibration exposure level, it is also necessary to take into account the times when the tool is switched off or running but not actually in use. This may significantly decrease the exposure level over the total working period.

Identify additional safety measures to protect the operator from the effects of vibration such as: maintain the tool and the cutting accessories, keep the hands warm, organisation of work patterns.



### **CAUTION!**

*Wear ear defenders at a sound pressure above 85 dB(A).*

## Instructions for use

### **WARNING!**

Remove the battery before carrying out any work on the power tool.

### Before switching on the power tool

Unpack the power tool and accessories and check that no parts are missing or damaged.

### **NOTE**

The batteries are not fully charged on delivery. Prior to initial operation, charge the batteries fully. Refer to the charger operating manual.

### Inserting/replacing the battery



- Press the charged battery into the power tool until it clicks into place.

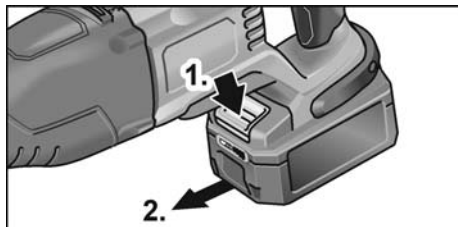

- To remove, press the release button (1.) and pull out the battery (2.).

### **CAUTION!**

When the device is not in use, protect the battery contacts. Loose metal parts may short-circuit the contacts; explosion and fire hazard!

## Battery state of charge

- Press the button to check the state of charge at the state of charge indicator LEDs.

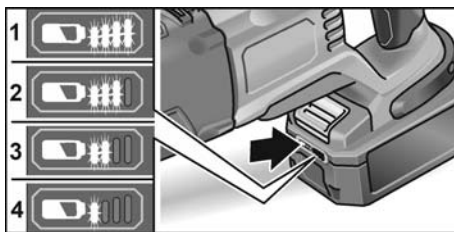

If one of the LEDs flashes, the battery must be recharged. If none of the LEDs light up after the button is pressed, the battery is faulty and must be replaced.

The indicator goes out after 5 seconds.

### **NOTE**

Follow the instructions for charging the battery set out in the charger operating manual.

### Inserting/changing the saw blades

#### **WARNING!**

Remove the battery before carrying out any work on the power tool.

### Discharging used saw blade

#### **CAUTION!**

- Used cutting accessories may become hot. Wear protective gloves!
- Ensure that no persons, animals or sensitive surfaces are in the line of fire when discharging.

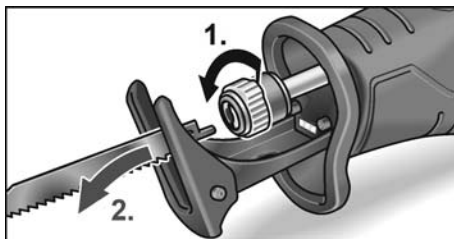

- Release tool holder lock by turning anti-clockwise and hold (1.). Used saw blade is discharged under spring pressure (2.).

**i NOTE**

If used saw blade is not discharged, pull saw blade forwards out of tool holder.

**Inserting new saw blade**

Select a saw blade to suit the material to be machined. Refer to the manufacturer's catalogues for details of saw blades that can be used.

**⚠ CAUTION!**

Risk of injury from cutting teeth. Wear protective gloves!

- Tool holder must be free of saw residue. Remove contamination with compressed air or a brush.

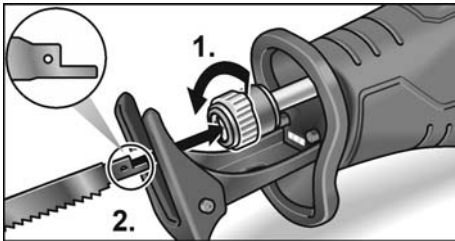

- Release tool holder lock by turning anti-clockwise and hold (1.).
- Insert new saw blade into tool holder and push in as far as it will go (2.).
- Release lock of tool holder; lock is engaged under spring pressure.
- Pull saw blade several times to ensure that the attachment is secure.

**i NOTE**

If tool holder lock does not engage correctly, engage tool holder lock by turning in clockwise direction.

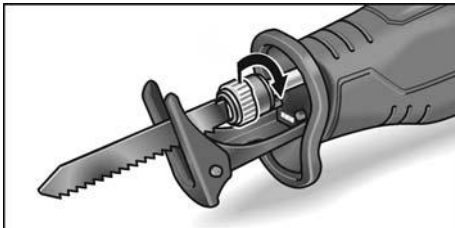
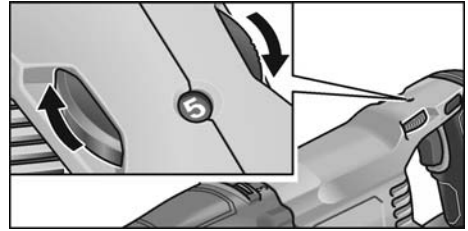
**Stroke number control**

- To set the stroke number, move the thumb wheel to the required value.

The appropriate stroke number depends on the material to be processed and can be determined by performing test cuts.

In general, select a high stroke number for cutting wood.

A lower stroke number is required for cutting metal and plastic.

**Setting the stroke type**

Two stroke types can be selected: Straight stroke and pendulum stroke.

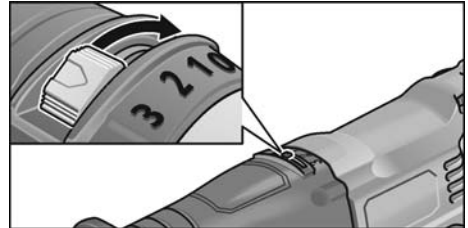
**Straight stroke ↔ Stage 0**

The saw performs horizontal movements only. Particularly suitable for cutting metal. If a very good cross-section is required when sawing wood, also use the straight stroke.

**Pendulum stroke**

The saw performs horizontal and vertical movements (pendulum movements). The stroke type is particularly suitable for cutting wood quickly.

Infinitely adjustable stroke height (stage 1-3):

Stage	Stroke height
1	1 mm
2	2 mm
3	3 mm

## Adjusting the cutting support

### **⚠ WARNING!**

Remove the battery before carrying out any work on the power tool.

The cutting support should always rest on the material when sawing so as to avoid excessive vibrations.

It is possible, for example, to limit the saw blade cutting depth by adjusting the cutting support.

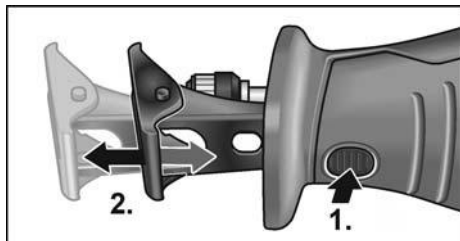

- Push cutting support lock (1.).
- Adjust the cutting support to the required depth (2.).
- Release cutting support lock.

## Switching the power tool on/off

The power tool switch allows the operator to increase the stroke rate slowly up to the maximum setting.

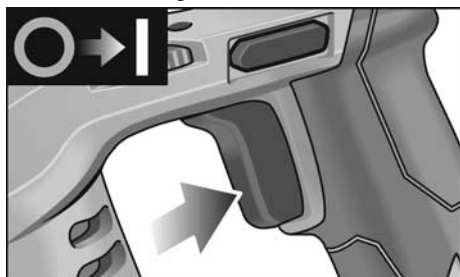

- Press and hold down the switch.  
The power tool starts.
- The LED illuminates the working area when the power tool is switched on.
- To switch off the tool:
- Release the switch.

## Operating instructions

### **⚠ WARNING!**

Always hold the power tool firmly with both hands!

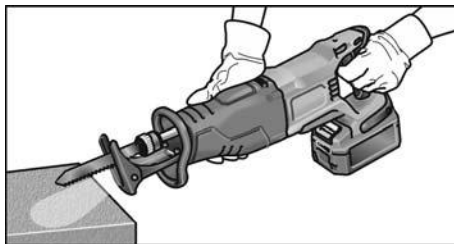

- Whenever possible, clamp the workpiece to be cut in a vice.
- The saw has a cutting support. This helps to reduce vibrations. It also enables square cuts to be made.
- After the power tool has been switched off, the saw blade continues running briefly.
- Never touch the saw blade straight after use as it may be very hot.

## Sawing metal

When sawing metal, use lubricant along the cutting line. This stops the material from overheating.

## Sawing wood

Place the saw square on the workpiece. Guide the saw with uniform pressure through the wood, pressing the cutting support against the workpiece in the process.

## Sawing directly at the wall

Thanks to the elasticity of bi-metal saw blades it is possible to cut pipes flush with the wall. To do so, use a saw blade of sufficient length that exceeds the diameter of the pipe. Position the saw blade flush with the wall so that the kink point is outside the workpiece to be sawn.

## Plunge cuts

The saw is suitable for plunge cuts in wood and plastic. Use only short saw blades (<150 mm) to perform plunge cuts!

- Place the saw on the workpiece with the bottom edge of the cutting support in such a way that the saw blade does not touch the workpiece.

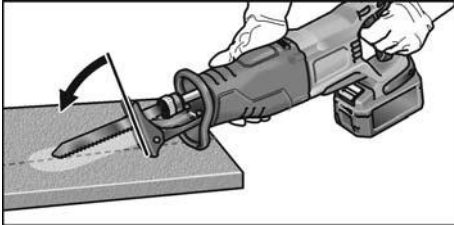

- Switch on the saw.
- Press the cutting support firmly against the workpiece and swing the saw forwards. Slowly plunge the saw blade into the workpiece.
- When the cutting support is resting fully on the workpiece, continue sawing along the desired cutting line.

### **i** NOTE

*Do not perform plunge cuts in metal.*

## Other information

- The use of “sharp” cutting accessories increases performance and the service life of the power tool.
- After work, clean the power tool and store in the carry case in a dry location.

### After the end of work:

Activate switch-on interlock or remove batteries to prevent unintentional start-up of the machine.

## Charger

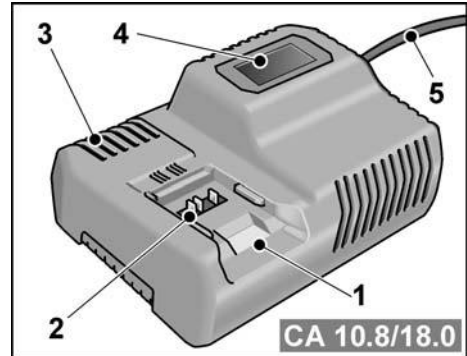

- 1 Insertion slot for battery
- 2 Contacts
- 3 Ventilation slots
- 4 Operating state display
- 5 Power cord with mains plug

The CA 10.8/18.0 charger is designed to charge FLEX batteries of the following types

- AP 10.8 (2.5 Ah),
- AP 18.0 (2.5 Ah),
- AP 10.8 (5.0 Ah),
- AP 18.0 (5.0 Ah).

### Tips for a long battery service life



#### CAUTION!

- *Never charge batteries at temperatures below 0 °C or above 55 °C.*
- *Do not charge batteries in environments with high air humidity or ambient temperature*
- *Do not cover batteries and the charger during the charging process.*
- *Pull out the charger mains plug at the end of the charging process.*

Battery and charger heat up during the charging process. This is perfectly normal! Lithium-ion batteries do not exhibit the established “memory effect”. Nevertheless, a battery should be completely discharged before charging and the charging process should always be fully completed.

If batteries are not used for an extended period of time, store them partially charged in a cool place.





## Charging process

### **CAUTION!**

Insert only original batteries in the supplied charger.

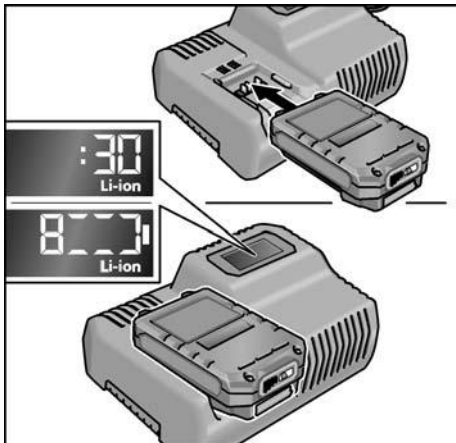
- Insert the charger mains plug. The display backlighting lights up green for 2 seconds and then goes out again. OK is displayed.



- Insert the battery fully into the charger until it clicks into place.
  - The time remaining in the charging process (until the battery is fully charged) and a graphic representation of the state of charge are shown alternately in the display.
  - The display backlighting lights up orange when the battery is charged less than 80%.
  - When the battery charge reaches 80% the display lights up green and OK is indicated.
- The battery is fully charged when the display  appears.

The green backlighting goes out after a short time.

- Remove the battery from the charger.

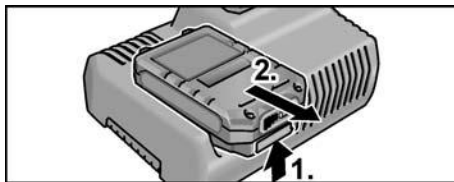

- Pull out the mains plug.

### **NOTE**

If the display flashes after the battery is inserted in the charger, there is a fault in the battery or in the charger.

 Display flashes slowly.  
Backlighting orange.

The battery is too hot or too cold. The charging process starts when the battery reaches the charging temperature (0°C...55°C).

 Display flashes rapidly.  
Backlighting red.

Remove the battery from the charger and insert again. If the same display persists, the battery is faulty. Replace the battery or have it checked at an authorised repair shop.

If this error message is displayed again with a different battery, this indicates that there is a fault in the charger. Have the charger checked at an authorised repair shop.

## Maintenance and care

### **WARNING!**

Remove the battery before carrying out any work on the power tool.

### Cleaning

#### **WARNING!**

If metals are worked over a prolonged period, conductive dust may become deposited inside the housing.

- Clean the power tool and ventilation slots at regular intervals. Frequency of cleaning is dependent on the material and duration of use.
- Regularly blow out the housing interior and motor with dry compressed air.

## Gear

### NOTE

*Do not loosen the screws on the gear head during the warranty period. Failure to comply with this requirement will invalidate any claims under the manufacturer's warranty.*

## Repairs

Repairs may be carried out by an authorised customer service centre only.

## Spare parts and accessories

For other accessories, in particular cutting accessories, please refer to the manufacturer's catalogues.

Exploded drawings and spare-part lists can be found on our homepage:

[www.flex-tools.com](http://www.flex-tools.com)

## Disposal information

### WARNING!

*Render redundant power tools unusable:*

- *mains operated power tool by removing the power cord,*
- *battery operated power tool by removing the battery.*



EU countries only

Do not throw electric power tools into the household waste!

In accordance with the European Directive 2012/19/EU on Waste Electrical and Electronic Equipment and transposition into national law used electric power tools must be collected separately and recycled in an environmentally friendly manner.

### Raw material recovery instead of waste disposal.

Device, accessories and packaging should be recycled in an environmentally friendly manner. Plastic parts are identified for recycling according to material type.

### WARNING!

*Do not throw batteries into the household waste, fire or water. Do not open used batteries.*

EU countries only:

In accordance with Directive 2006/66/EC defective or used batteries must be recycled.

### NOTE

*Please ask your dealer about disposal options.*

## CE conformity

We declare on our sole responsibility that the product described under "Technical data" conforms to the following standards or normative documents:

EN 62841 according to the provisions of Directives 2014/30/EU, 2006/42/EC, 2011/65/EU.

Responsible for technical documents:  
FLEX-Elektrowerkzeuge GmbH, R & D  
Bahnhofstrasse 15, D-71711 Steinheim/Murr

Eckhard Rühle  
Manager Research &  
Development (R & D)

Klaus Peter Weiper  
Head of Quality  
Department (QD)

20.04.2018

FLEX-Elektrowerkzeuge GmbH  
Bahnhofstrasse 15, D-71711 Steinheim/Murr

## Exemption from liability

The manufacturer and his representative are not liable for any damage and lost profits due to interruption in business caused by the product or by an unusable product.

The manufacturer and his representative are not liable for any damage which was caused by improper use of the power tool or by use of the power tool with products from other manufacturers.