

STABILA®

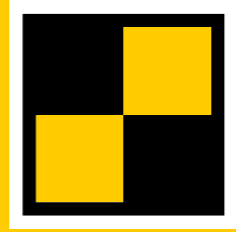

How true pro's measure

TECH 196 DL Series

Operating instructions

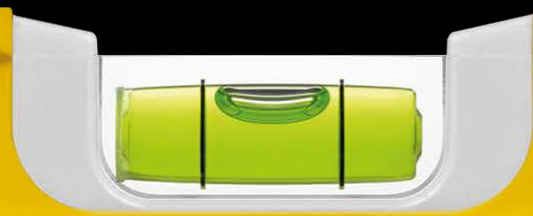

STABILA® 

MADE IN GERMANY

WWW.STABILA.COM

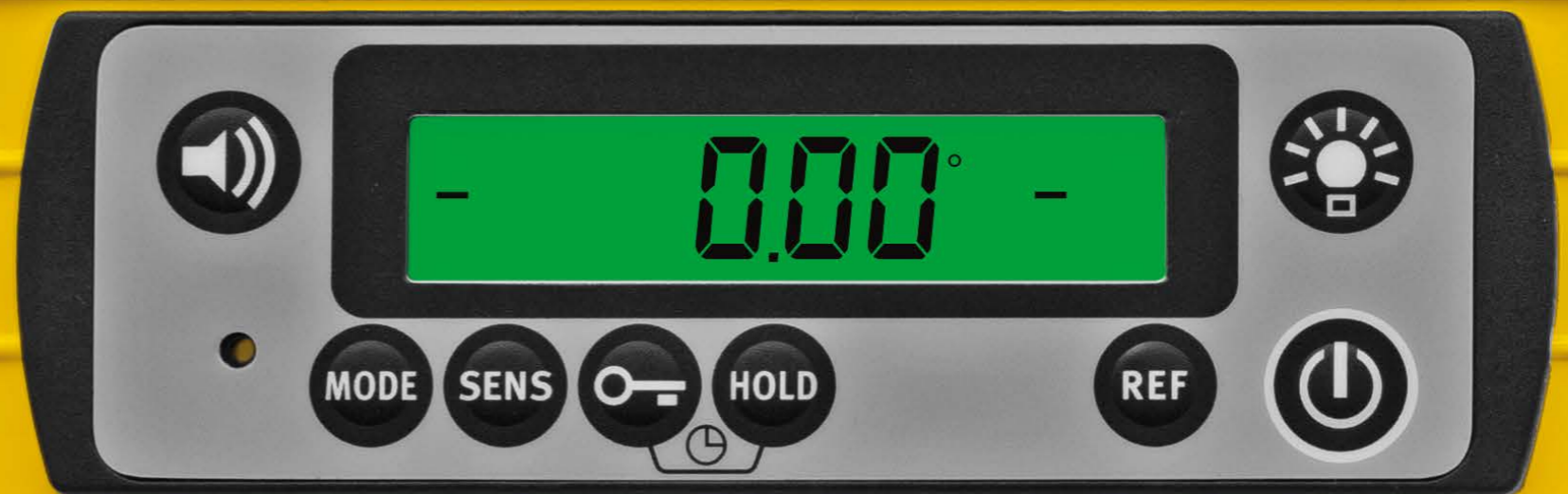

Contents

Section	Page
• 1. Intended use	3
• 2. Safety information	3
• 3. Description of the unit	4
• 3.1 Components of the unit	4
• 3.2 Buttons	5
• 3.3 Display elements	5
• 4. Commissioning	6
• 4.1 Inserting/replacing batteries	6
• 4.2 Switching the unit on	6
• 5. Functions	7
• 5.1 Visual guidance	7
• 5.2 Acoustic guidance	8
• 5.3 Setting the unit of measurement	9
• 5.4 Automatic display inversion	13
• 5.5 Locking the measurement with HOLD	13
• 5.6 Freely selectable zero position REF	14
• 5.7 Lighting	15
• 5.8 Keylock	15
• 5.9 Automatic switch-off time: Auto OFF	15
• 6. Tilt function	16
• 7. Checking the measuring tool	17
• 7.1 Accuracy check	17
• 7.2 Calibration	18
• 8. Technical data	19

1. Intended use

Congratulations on the purchase of your STABILA measuring tool. Electronic spirit levels in the STABILA TECH 196 DL series enable you to measure inclinations and angles quickly and easily.



If you still have questions after reading through the operating instructions, you can obtain advice by telephone:

49 63 46 3 09 0

Equipment and functions:

1. Electronic module with 2 illuminable digital displays for accurately determining inclinations
2. Vertical vial(s) for vertical levelling, in reverse position too
3. Horizontal vial for horizontal levelling, in reverse position too
Note: The TECH 196 DL 23cm / 9 ' without vials.

TECH 196 M DL:

4. Extra-strong rare earth magnets

2. Safety information

Read the safety instructions and operating instructions through carefully.

3. Description of the unit



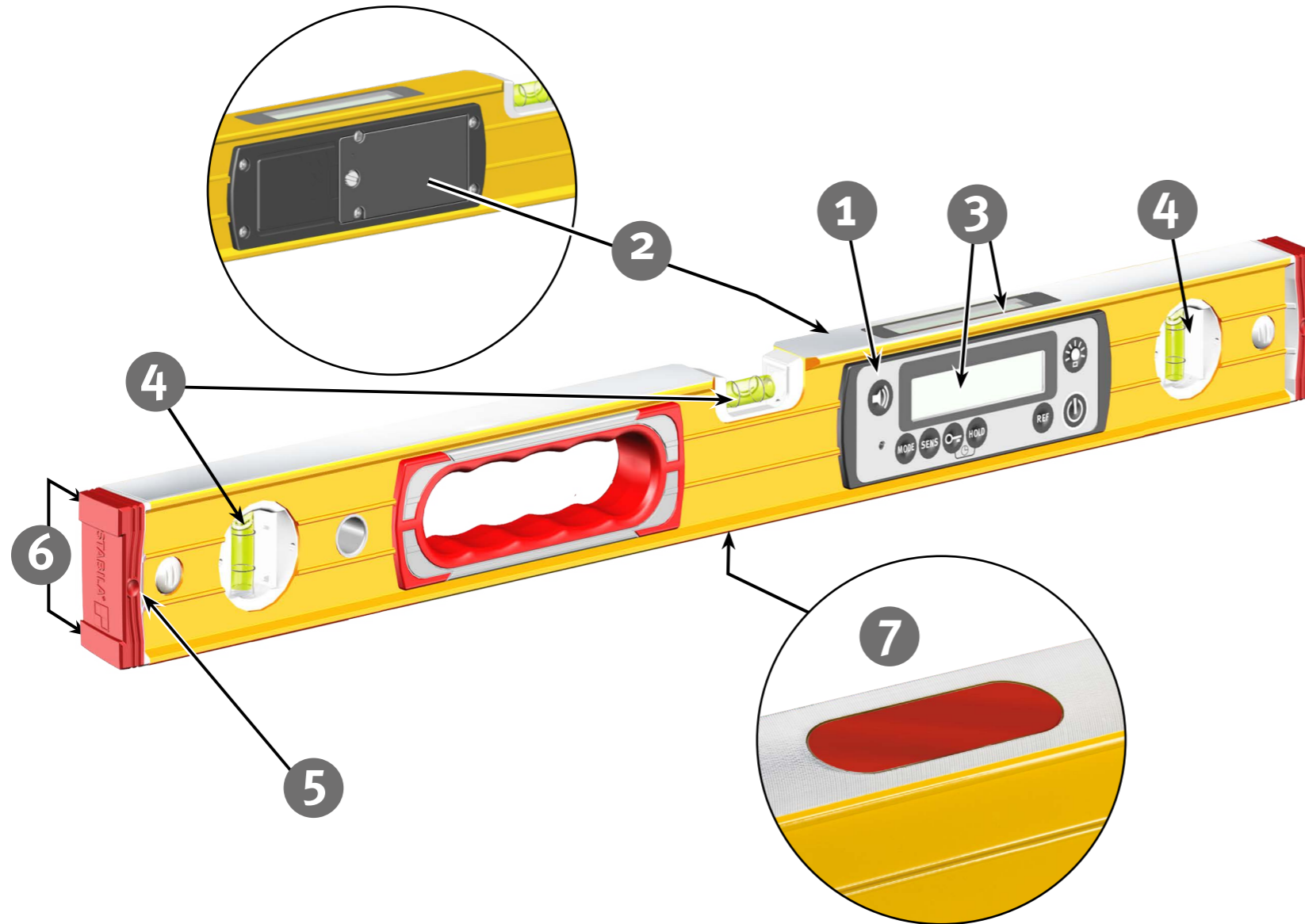



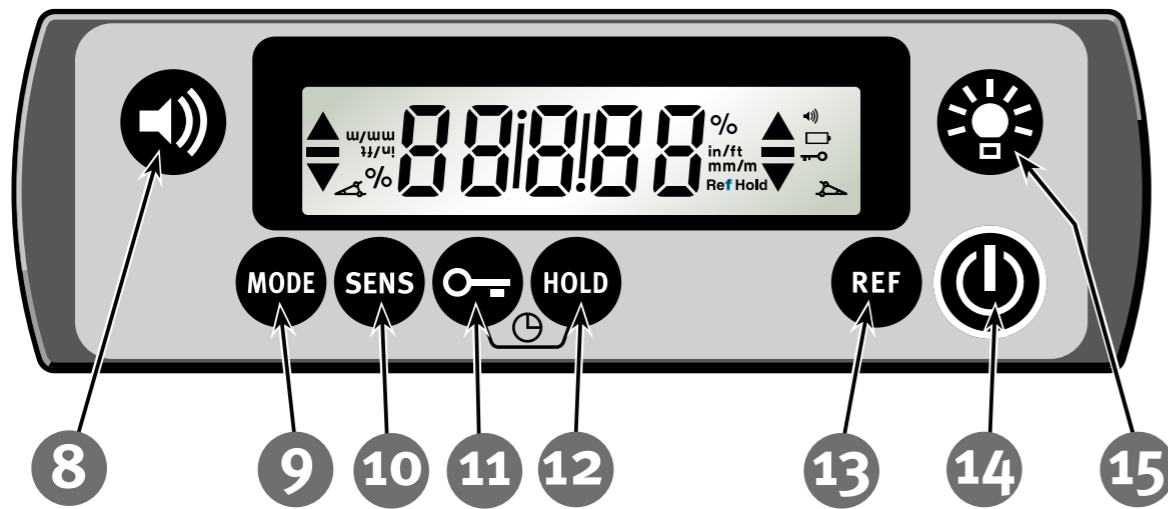

3.1 Components of the unit



- (1) Electronic module
(dustproof and waterproof in accordance with IP 67)
- (2) Battery compartment lid
- (3) 2 displays
- (4) Vials – vertical and horizontal
(not with 23cm / 9" length)
- (5) Removable, shock-absorbing end caps
- (6) Slip stopper
- (7) Rare-earth magnet (TECH 196 M DL)

3.2 Buttons



-  (8) Acoustic guidance
-  (9) Units of measurement: °, %, mm/m, in/ft, roof pitch guidance
-  (10) Sensitivity
-  (11) Keylock
-  (12) HOLD – lock measurements
-  (13) Reference – freely selectable zero position
-  (14) On/Off
-  (15) Display lighting

3.3 Display elements



- (16) Elements for visual guidance
- (17) Units of measurement: °, %, mm/m, in/ft
- (18) Acoustic guidance: activated
- (19) Battery low - see chapter 5.1
- (20) Roof pitch guidance: activated
- (21) Keylock: activated
- (22) Lock measurements: activated
- (23) Reference: activated

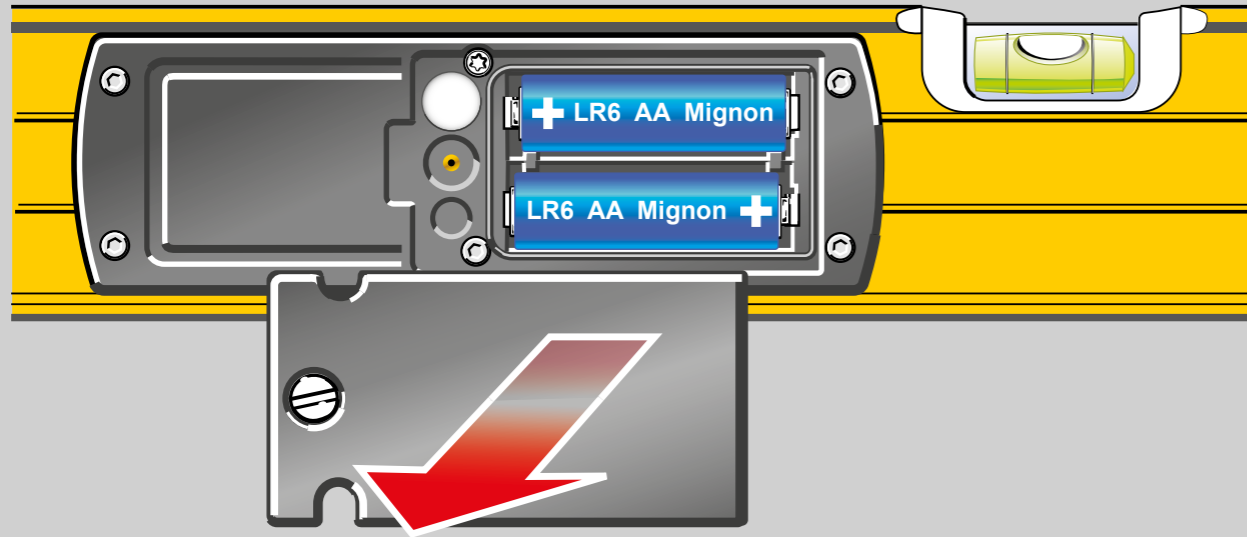

2x 1,5V
Alkaline
AA, LR6, Mignon
MN 1500

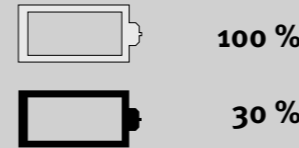

4. Commissioning

4.1 Inserting/replacing batteries

Unscrew battery compartment lid on rear and insert new batteries according to symbol in battery compartment. Suitable rechargeable batteries can also be used.

Display :
Battery low – insert new batteries



Dispose of used batteries at suitable collection points – not with household waste. Do not leave in unit!

If you do not intend to use the unit for an extended period, remove the batteries!



Software Version

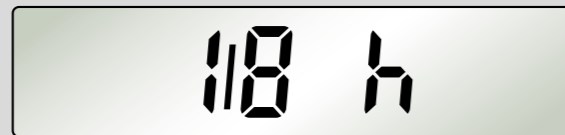

Auto OFF

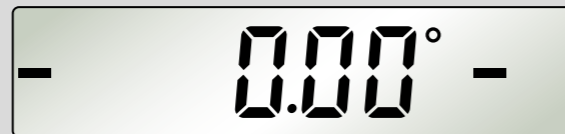

4.2 Switching the unit on

When the unit is switched on ("On/Off" button), a signal sounds. The version number of the software (S x.xx) is briefly displayed and the automatic switch-off time (Auto OFF) is shown.

The display shows the angle measured in the set unit of measurement.

5. Functions

5.1 Visual guidance

In the range of $\pm 15^\circ$ to the horizontal (0°) or to the vertical (90°), arrows show which way to turn the inclination sensor to reach 0° or 90° .

The 2 "centre display" bars indicate the precise position at which 0° or 90° is reached.

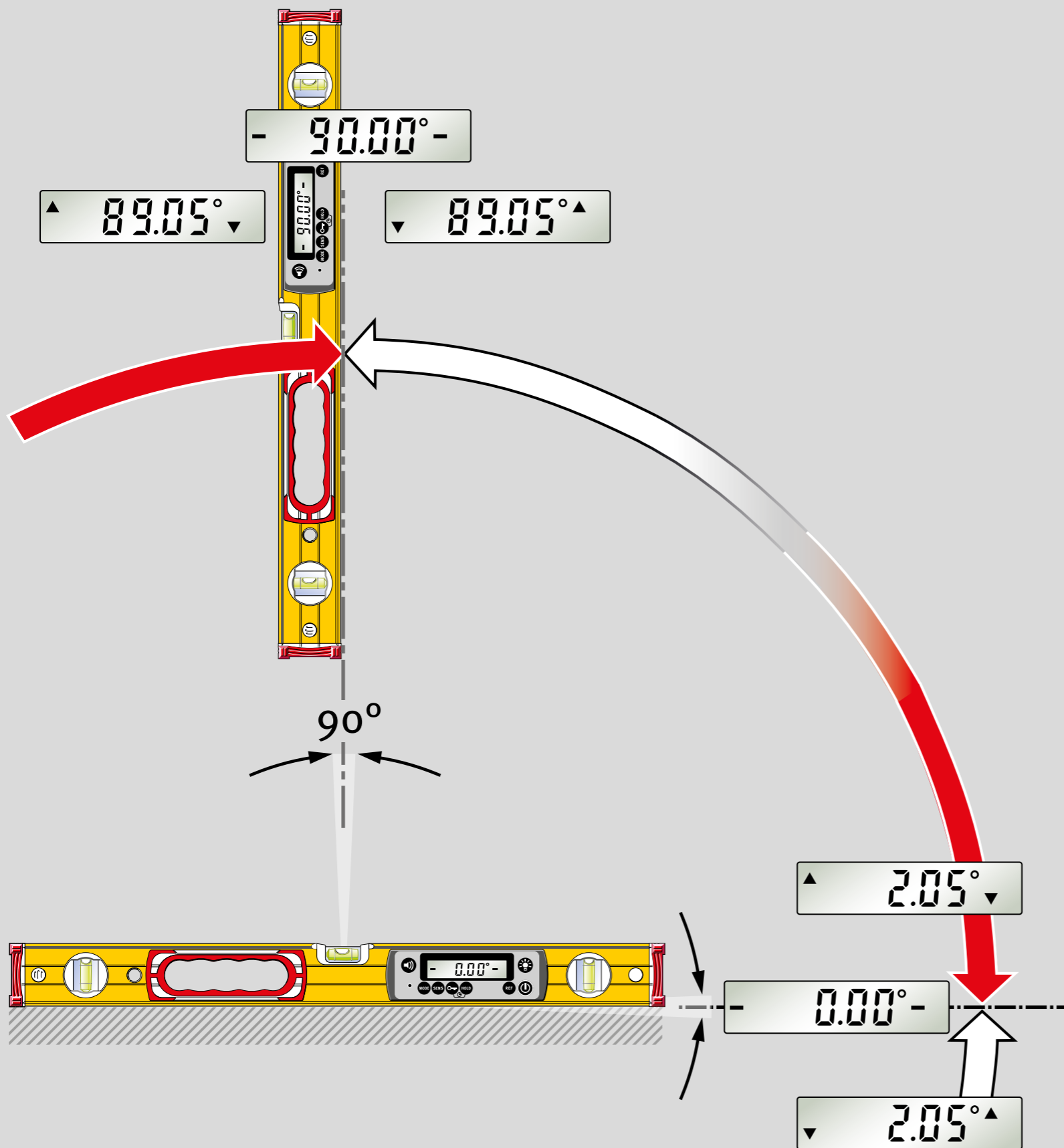

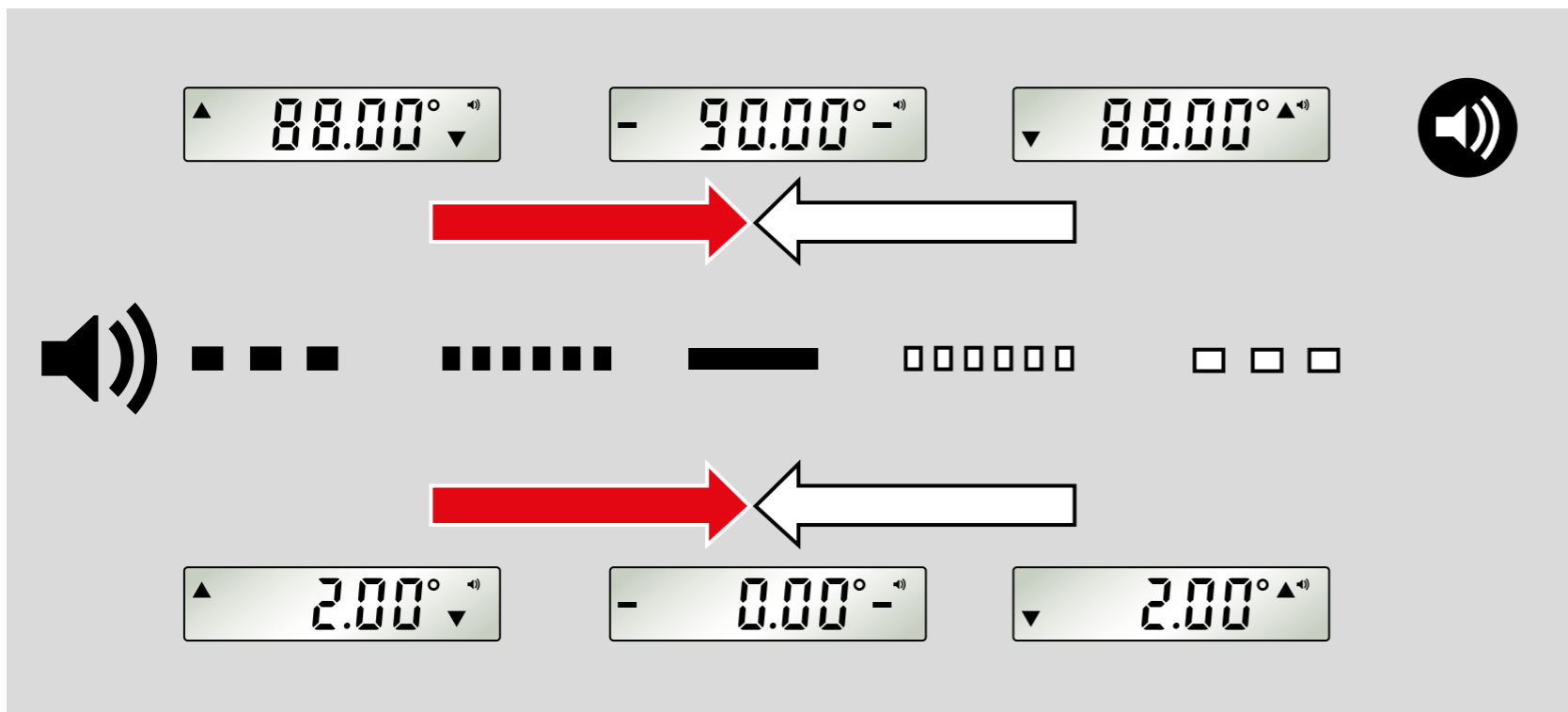

5.2 Acoustic guidance

The acoustic guidance is activated/deactivated using the "Loudspeaker" button. The tone sequence speeds up as the 0° or 90° position is approached in a range of ± 2°. A change in the pitch indicates that these positions have been exceeded.

A continuous tone confirms the precise point at which 0° or 90° is reached.

When roof pitch guidance is selected, the acoustic signals guide the user as the next roof pitch value is approached.

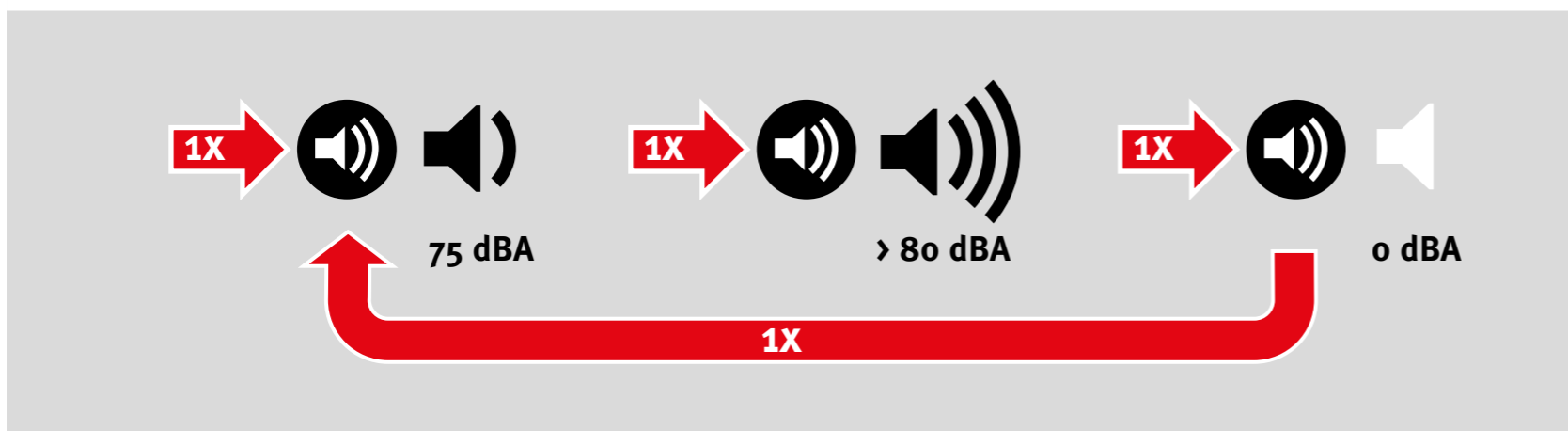

Setting acoustic guidance

1. The "Acoustic guidance" button can be used to set the volume.
2. quiet, loud or off.
3. When the volume is muted, only a short beep sounds. The setting is retained after the unit is switched off.

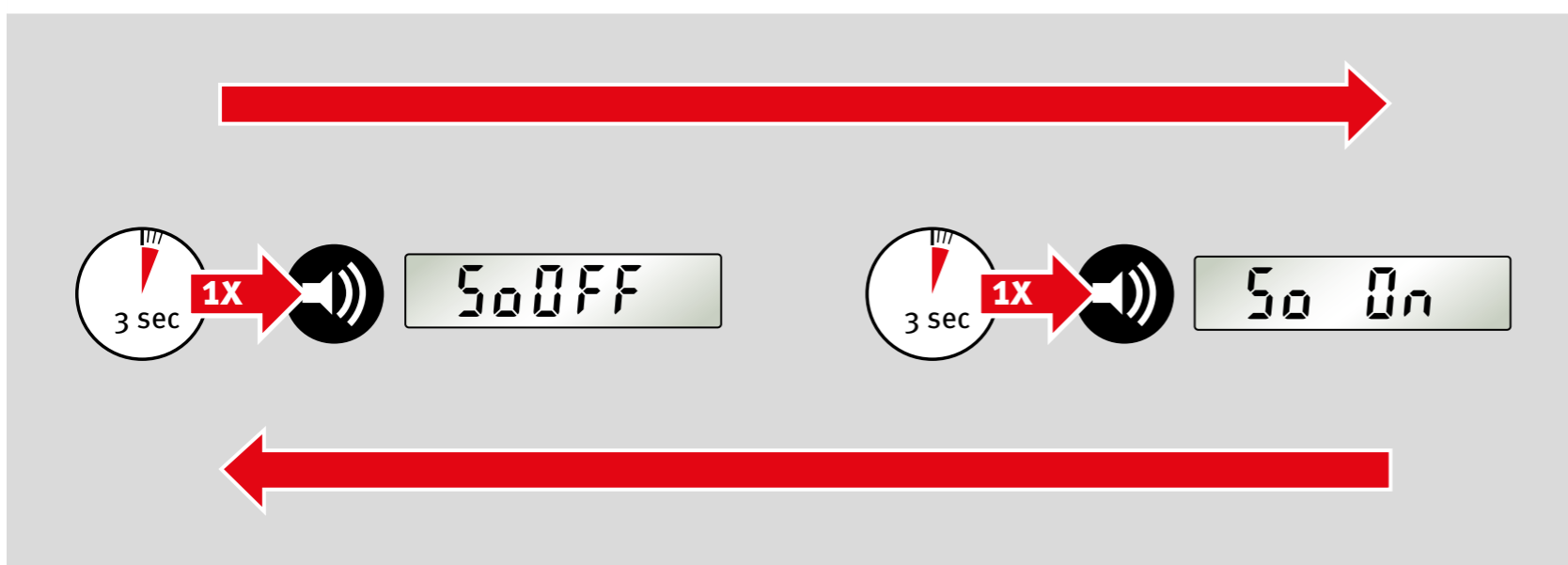

Setting the keypad tone

Pressing and holding the "Acoustic guidance" button switches the keypad tone off and on.

The setting is retained after the unit is switched off.

MODE °

SENS

▲ 10.0 ° ▼

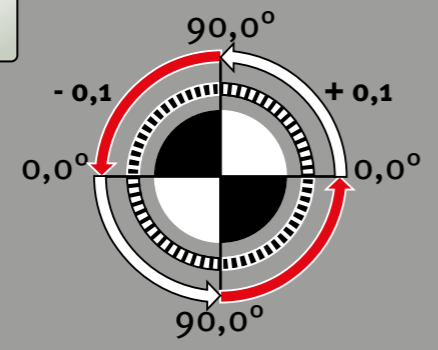

SENS

▲ 10.05 ° ▼

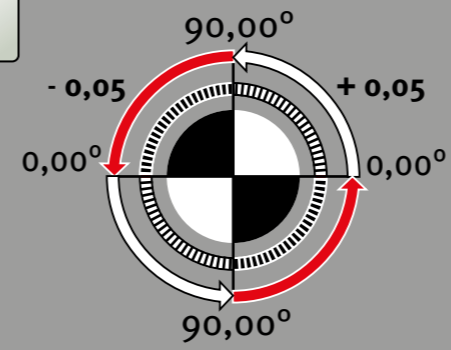

MODE %

SENS

▲ 17 % ▼

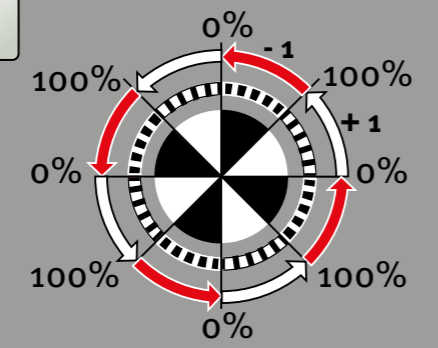

SENS

▲ 17.7 % ▼

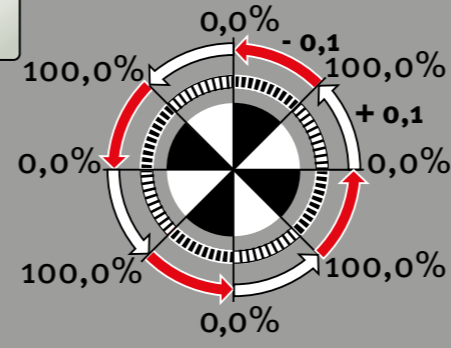

MODE mm/m

▲ 17 mm/m ▼

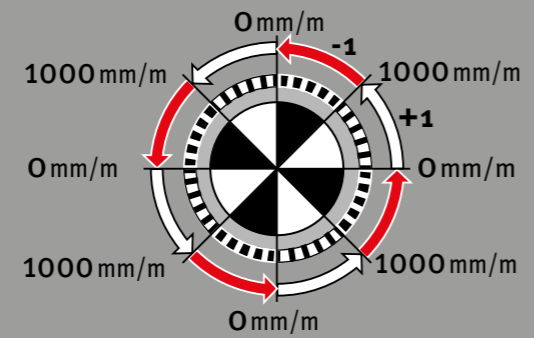

5.3 Setting the unit of measurement

The unit of measurement is set by pressing the "MODE" button multiple times.

°, %, mm/m, in/ft (decimal, fractal), roof pitch guidance

The sensitivity is adjusted with the "SENS" button.

The settings for unit of measurement and sensitivity are retained after the unit is switched off.

MODE: °

SENS: Display 0.0° - 90.0° in +0.1° steps
 Display 90.0° - 0.0° in -0.1° steps

SENS: Display 0.00° - 90.00° in +0.05° steps
 Display 90.00° - 0.00° in -0.05° steps

MODE: %

SENS: Display 0% - 100% in +1% steps
 Display 100% - 0% in -1% steps

SENS: Display 0.0% - 100.0% in +0.1% steps
 Display 100.0% - 0.0% in -0.1% steps

MODE: mm/m

SENS: Display 0 - 1000mm/m in +1 mm/m steps
 Display 1000 - 0mm/m in -1 mm/m steps

MODE in/ft decimal

SENS

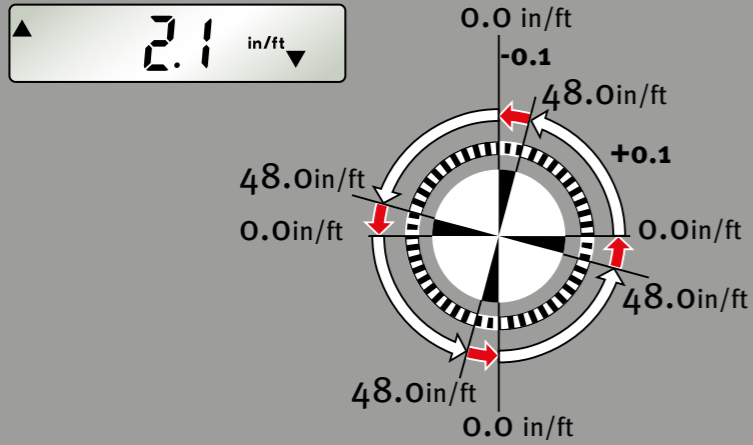

SENS

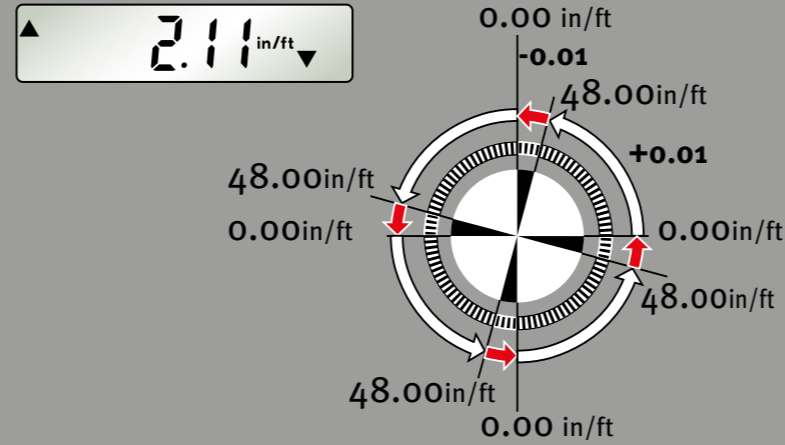

5.3 Setting the unit of measurement

MODE: in/ft decimal

SENS: Display 0.0 - 48.0 in/ft in +0.1 in/ft steps
 Display 48.0 - 0.0 in/ft in -0.1 in/ft steps

SENS: Display 0.00 - 48.00 in/ft in +0.01 in/ft steps
 Display 48.00 - 0.00 in/ft in -0.01 in/ft steps

MODE in/ft fractal

SENS

118 in/ft

▲ 2 118 in/ft ▼

SENS

116 in/ft

▲ 2 116 in/ft ▼

SENS

132 in/ft

▲ 2 132 in/ft ▼

SENS

164 in/ft

▲ 2 164 in/ft ▼

5.3 Setting the unit of measurement

MODE: in/ft fractal

Fine adjustment in the range 0 - 10 in/ft:

- SENS:** Display in + 1/8 in/ft steps
- SENS:** Display in + 1/16 in/ft steps
- SENS:** Display in + 1/32 in/ft steps
- SENS:** Display in + 1/64 in/ft steps

Fixed angles:

- Display **10 - 48 in/ft** in + 1/8 in/ft steps
- Display **48 - 0 in/ft** in - 1/8 in/ft steps

As the unit is adjusted, the selected sensitivity is displayed for approx. 2 seconds.

5.3 Setting the unit of measurement

Roof pitch guidance

Roof pitch guide values for USA/Canada

Specifically for roof construction (USA, Canada), in Roof Pitch Guidance mode the inclination is shown in steps of 1/12. Intermediate values are shown as decimals in in/ft.

As the inclination approaches the next roof pitch value, this is also indicated by the acoustic guidance. A continuous tone confirms the precise point at which the roof pitch angle is reached.

MODE: Pitch  

Display of roof pitch: $0/12 - 48/12$ in $+1/12$ steps

Display of roof pitch: $48/12 - 0/12$ in $-1/12$ steps

Display of intermediate values: in 0.1 in/ft steps

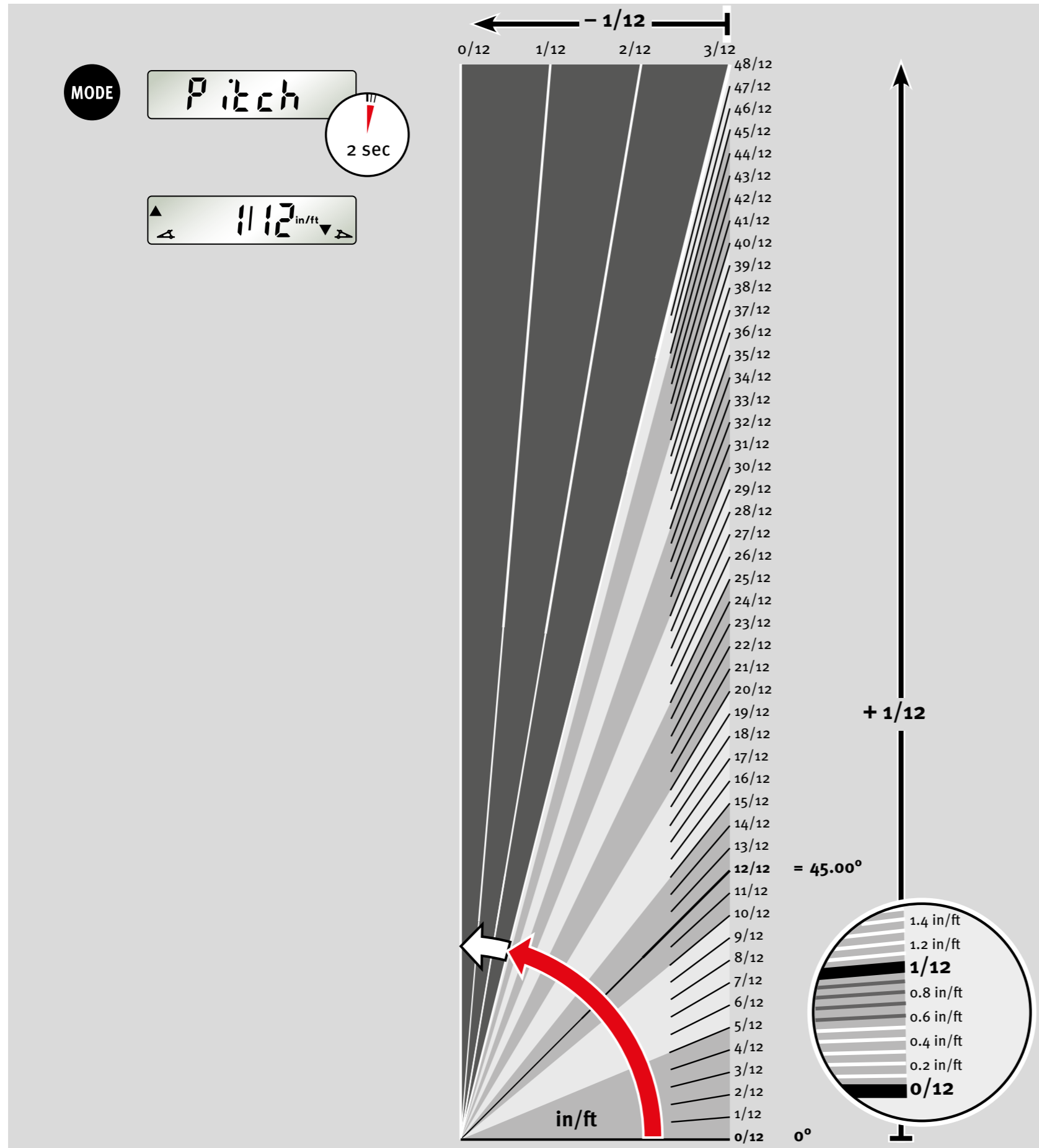

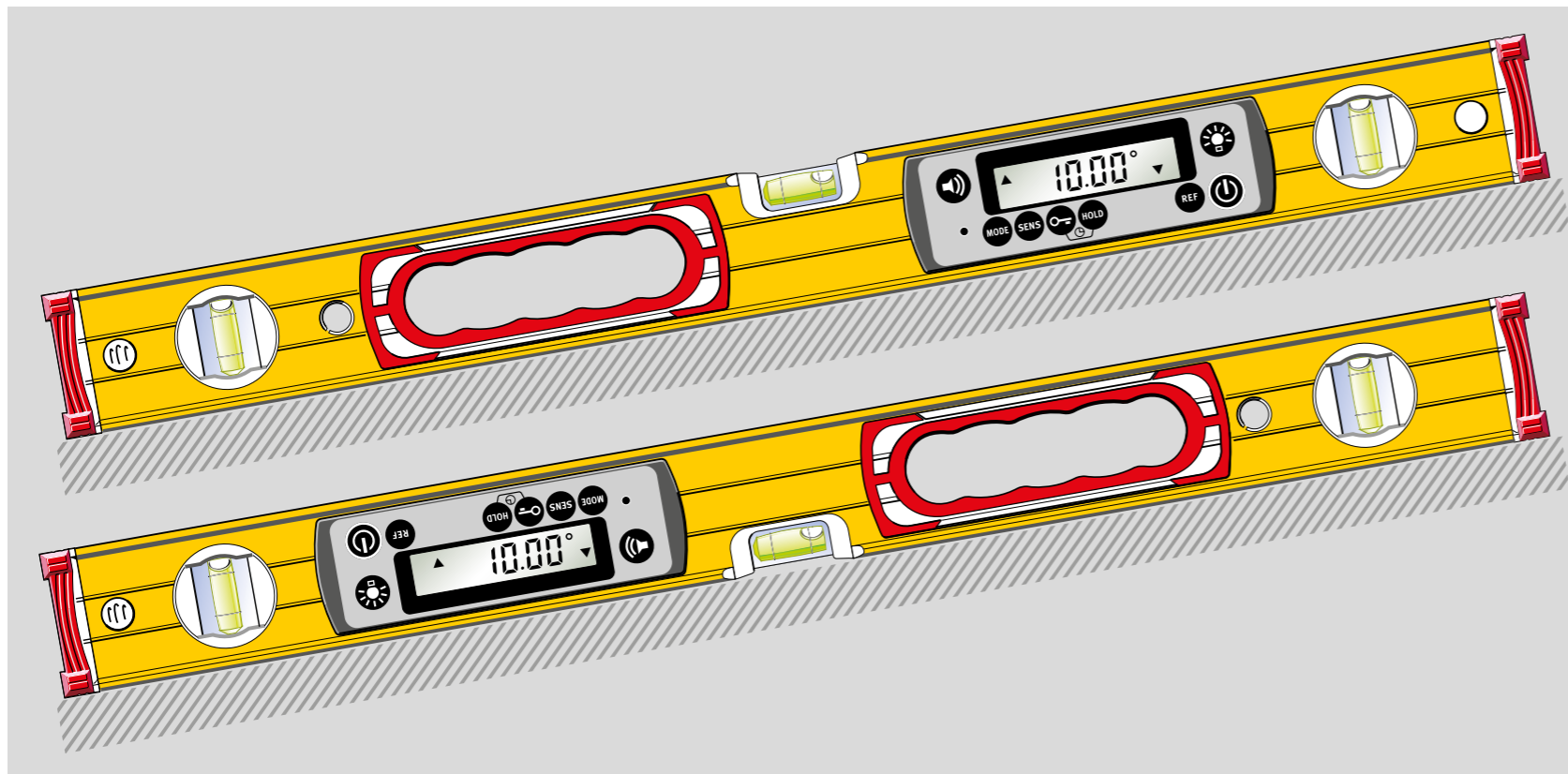

5.4 Automatic display inversion

The display is inverted for overhead measurements so that they are always easy to read.

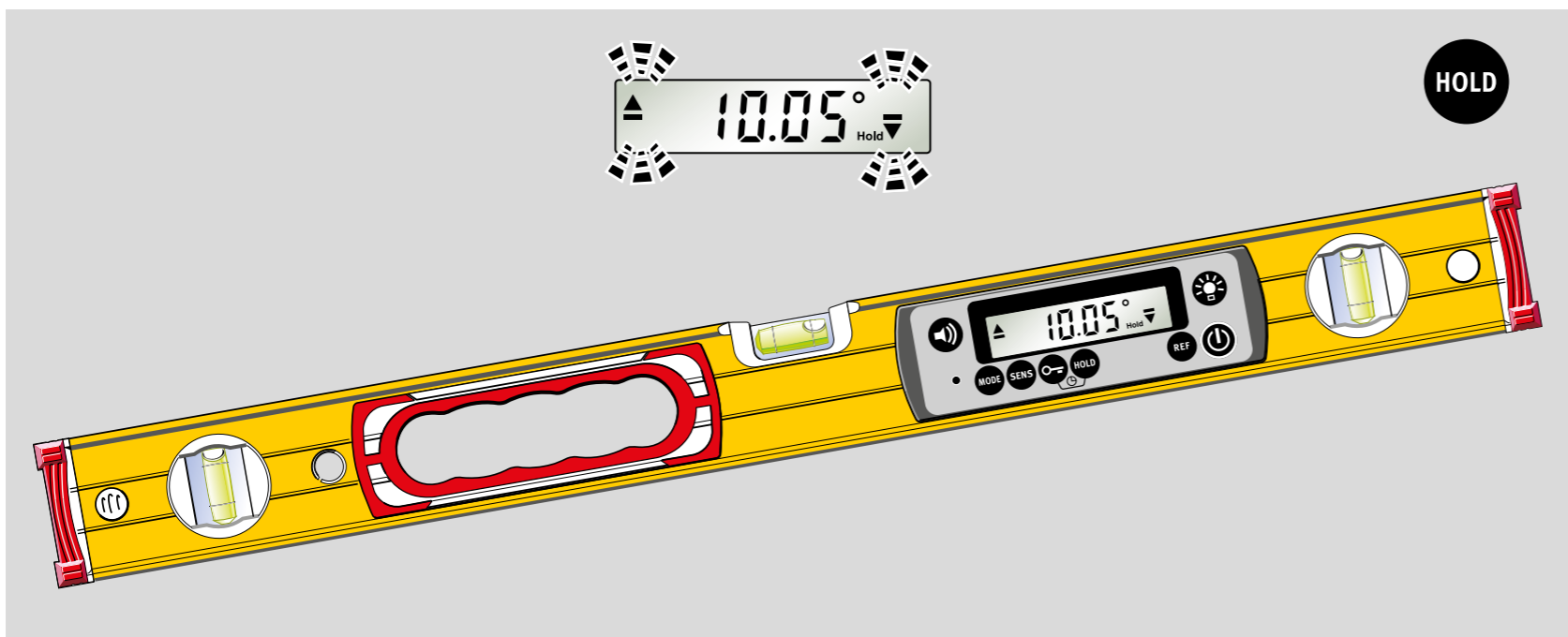

5.5 Locking the measurement with HOLD

The current measurement can be locked by pressing the "HOLD" button. The visual guidance indicator flashes. The measurement is displayed continuously. The locked measurement is deleted by pressing the "HOLD" button again or switching the unit off.

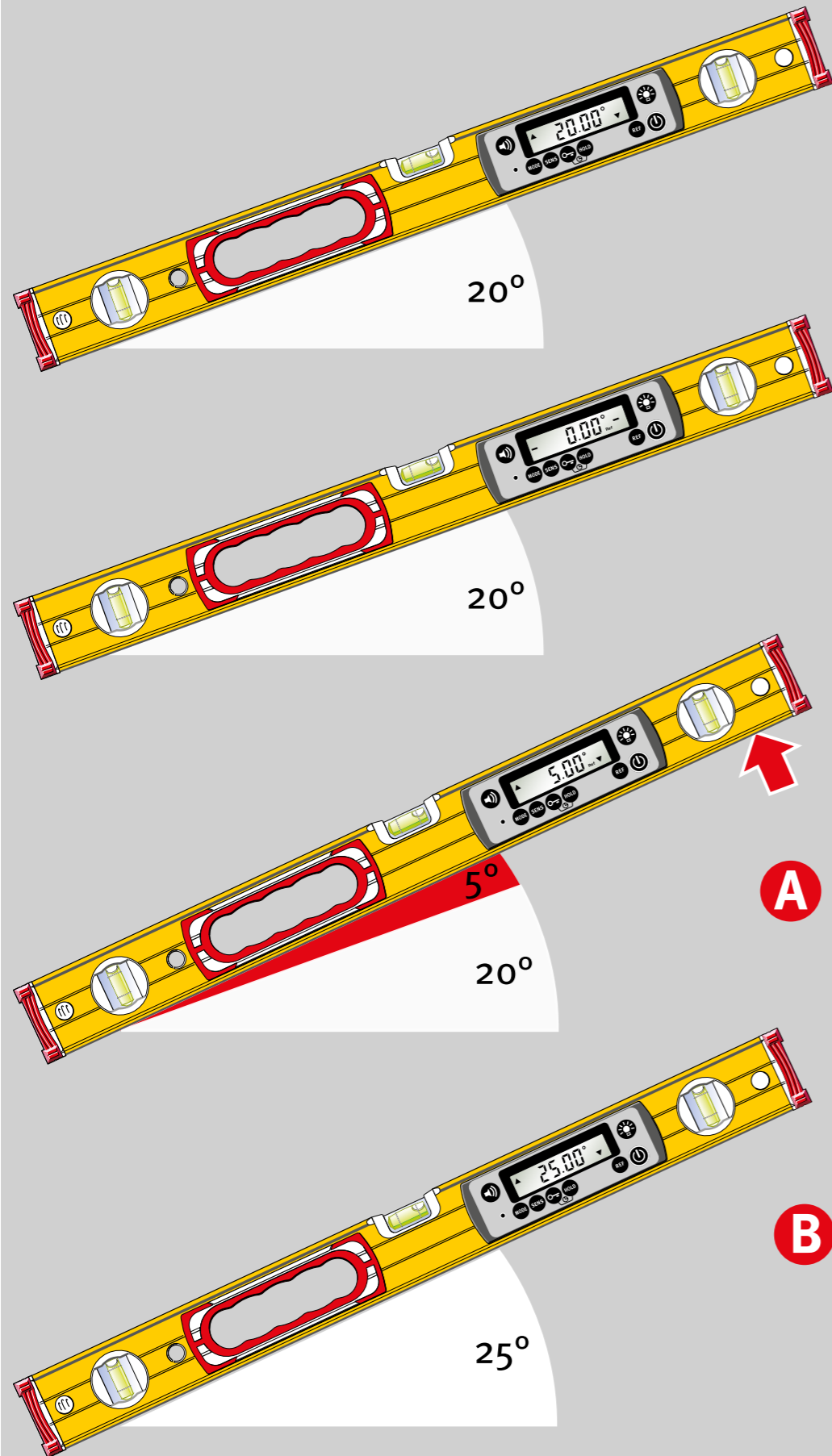

REFERENCE

20°



0°
(≅ 20°)



+5°
(≅ 25°)



20°
(+ 5°)

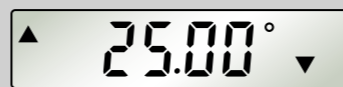

RESET
REFERENCE

5.6 Freely selectable zero position REF

The REF button can be used to select any set angle as 0° reference. The angle details now displayed relate to this reference angle.

The display flashes in this setting.

A

The original reference angle value is displayed for 2 seconds by briefly pressing the REF button.

B

The reference angle is deleted by:

- Pressing and holding (≥ 3 sec) the REF button
If the keylock is active, this must be disabled first.
- Switching off
- The automatic switch-off function

The zero position again refers to the calibrated setting.

The chosen orientation of the electronic spirit level must not be changed while using the reference function!

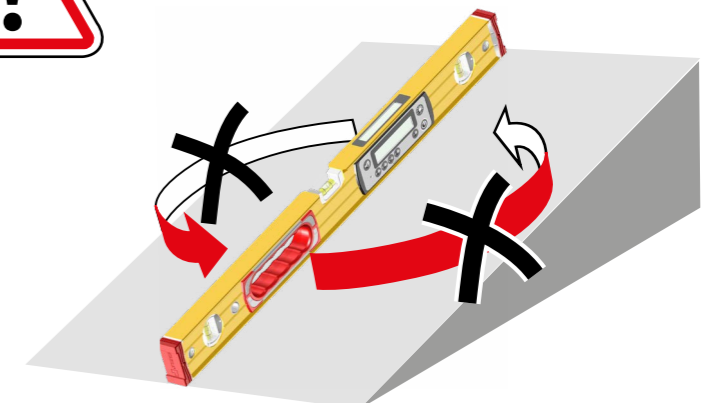

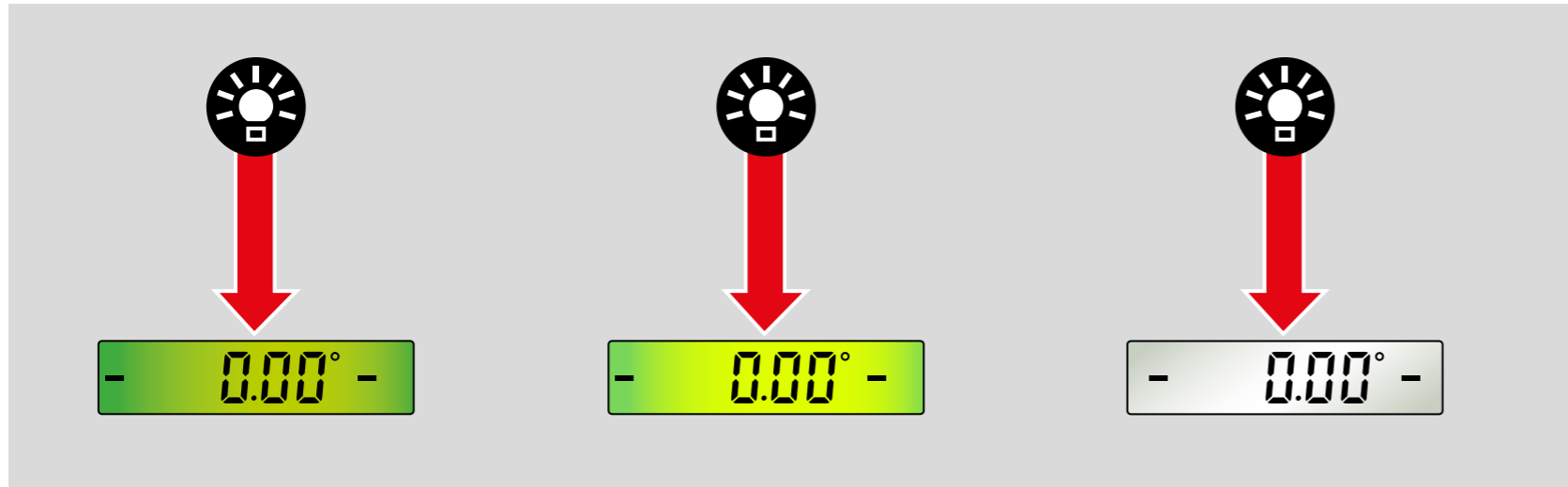

5.7 Lighting

Briefly pressing the "Lighting" button switches the display lighting on, brighter, off. The setting is retained after the unit is switched off.

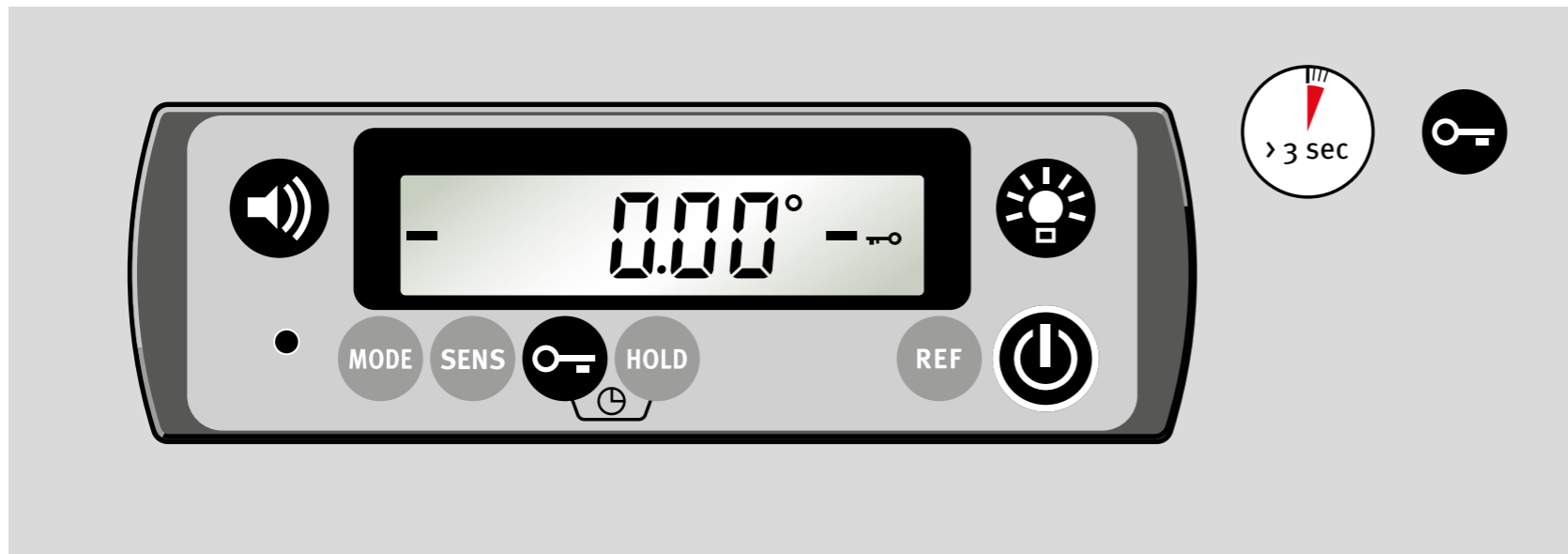

5.8 Keylock

Pressing and holding the "Key" button (≥ 3 sec) switches keylock on/off.

The buttons

"MODE, SENS, HOLD, REF"

are locked to prevent unintentional activation. The setting is retained after the unit is switched off.

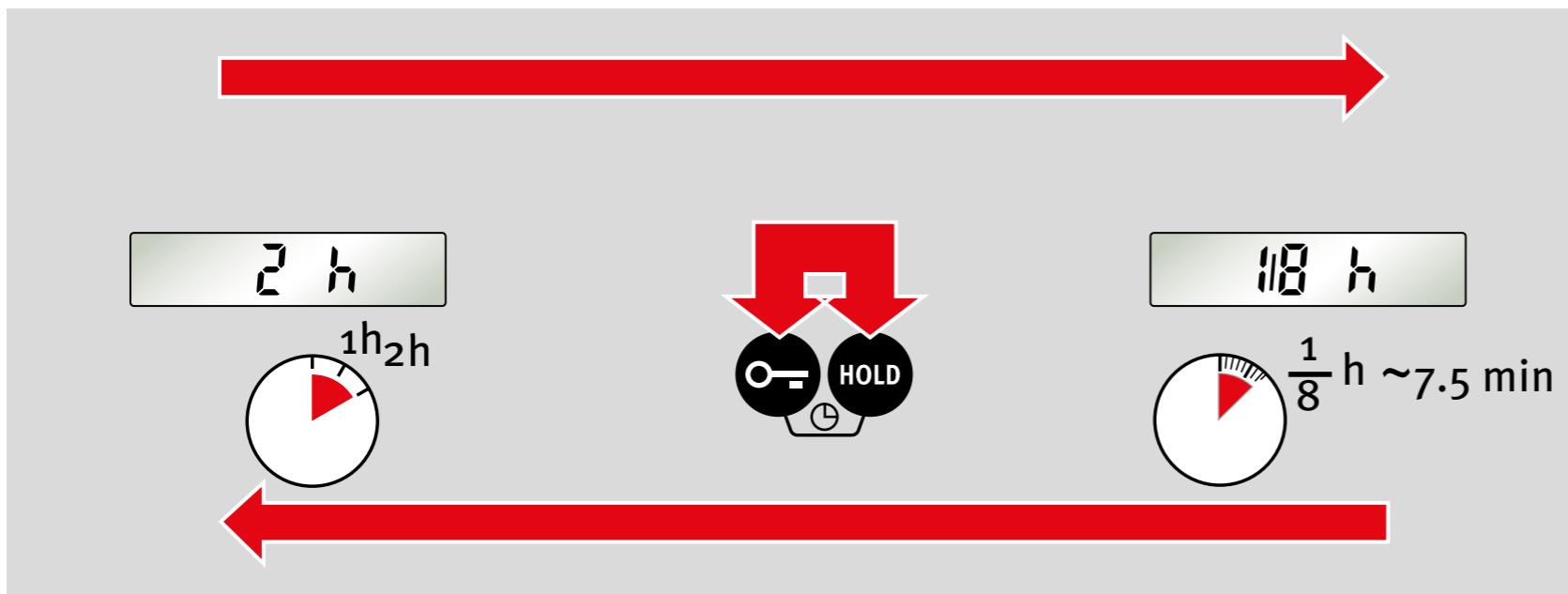

5.9 Automatic switch-off time: Auto OFF

Pressing the "Key" and "HOLD" buttons at the same time allows the automatic switch-off time to be changed from 2 hours to 1/8 of an hour (approx. 7.5 minutes). The set switch-off time is retained after the unit is switched off and is displayed briefly when it is switched on again.

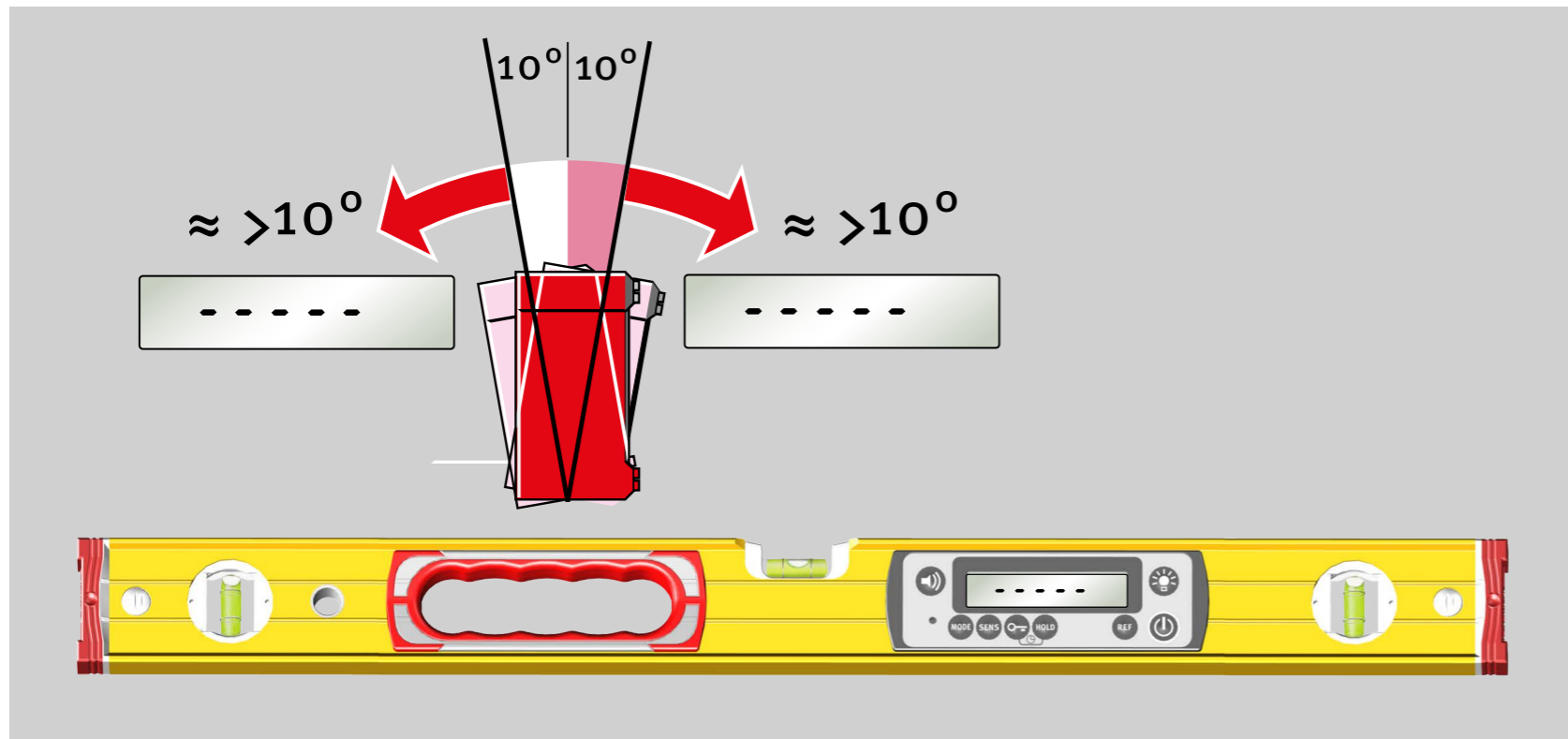

6. Tilt function

The measuring surfaces of the electronic spirit level should be positioned precisely for all measurement work. If the spirit level is positioned at too great an angle, the tilt function prevents incorrect measurements. This stops the display from showing an incorrect measurement.

7. Checking the measuring tool

7.1 Accuracy check



To prevent measuring errors, the accuracy of the measuring tool must be checked at regular intervals; for example, each time before beginning work, or after a heavy impact or extreme fluctuations in temperature.

Step 1:

The unit of measurement ° degrees and SENS 0.00° must be selected!

Place the unit with the lower measuring sole on as horizontal a surface as possible (e.g. a table) with the display side facing the user. Determine the measurement.

Step 2:

Turn the unit by 180° in the same position.

Step 3:

The rear of the unit is now facing the user.

Compare the new measurement with the measurement determined in step 1. In the case of deviations $> 0.05^\circ$, the unit must be calibrated again (-> Calibration).

$\Delta 1\ 3 \leq 0.05^\circ = \text{OK } \checkmark$

$\Delta 1\ 3 > 0.05^\circ \Rightarrow \text{calibrate}$

1

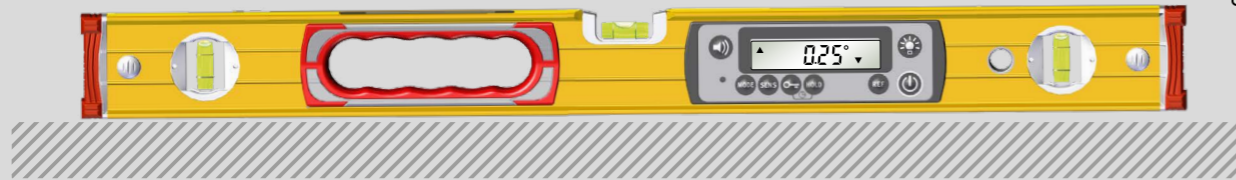

2

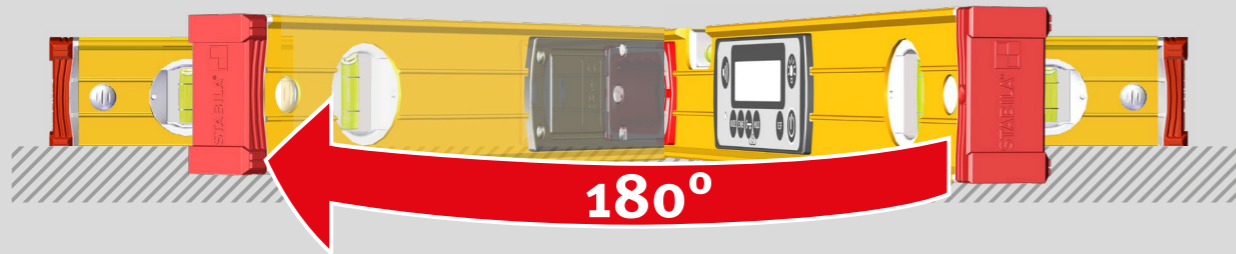

3

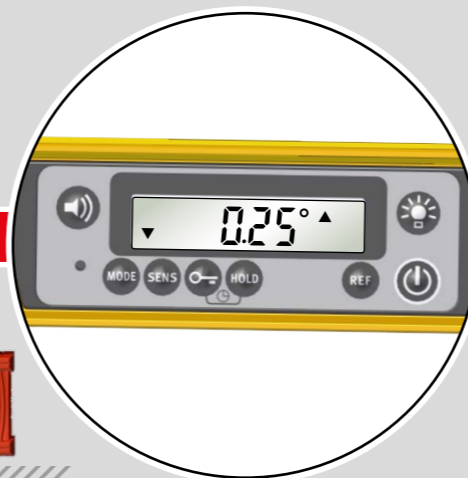
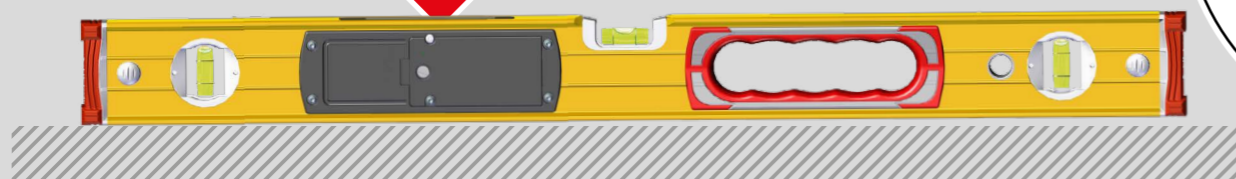

1

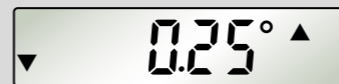

3

7.2 Calibration

Step 1: Use the "MODE" and "SENS" buttons to activate measuring sole calibration.

Display: CAL 1

Step 2:

Place the unit with the lower measuring sole on as horizontal a surface as possible (e.g. a table) with the display side facing the user. Press the "SENS" button to start calibration. "CAL" flashes in the display.

Display: CAL2

Calibration step 2 successfully completed

Step 3:

Turn the unit by 180° in the same position.

Step 4:

The rear of the unit is now facing the user. Press the "SENS" button to start the second calibration. "CAL" flashes in the display.

"rdy" display: Calibration completed successfully!

1

- CAL 1 -

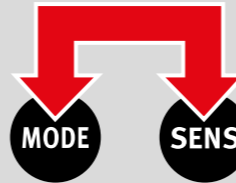
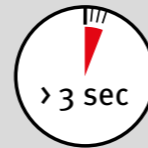

2

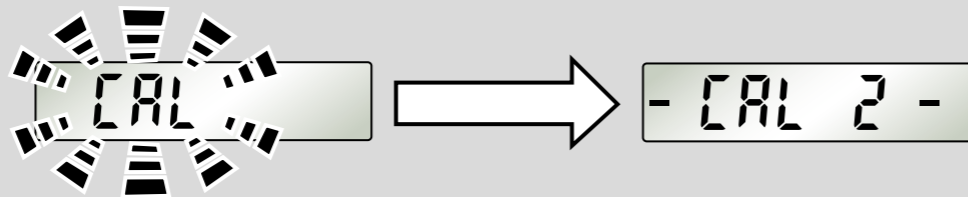
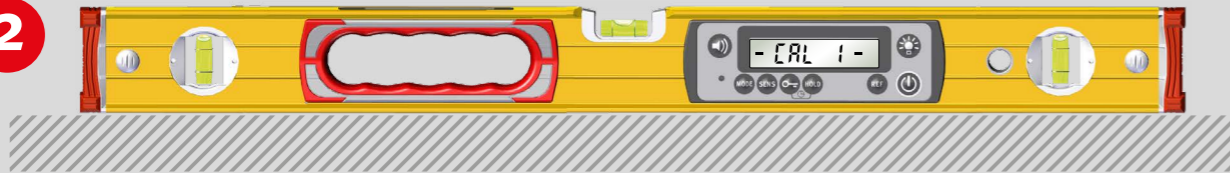

3

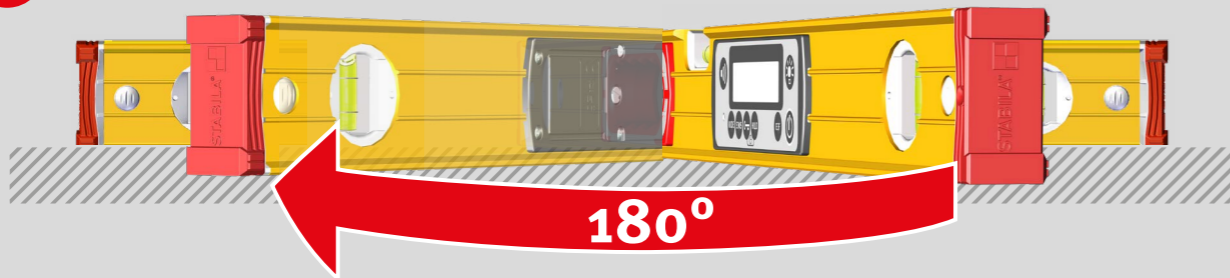

4

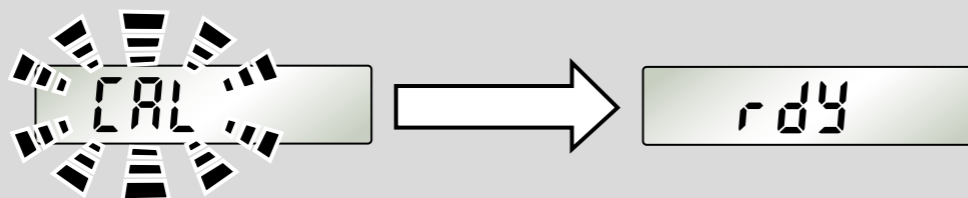
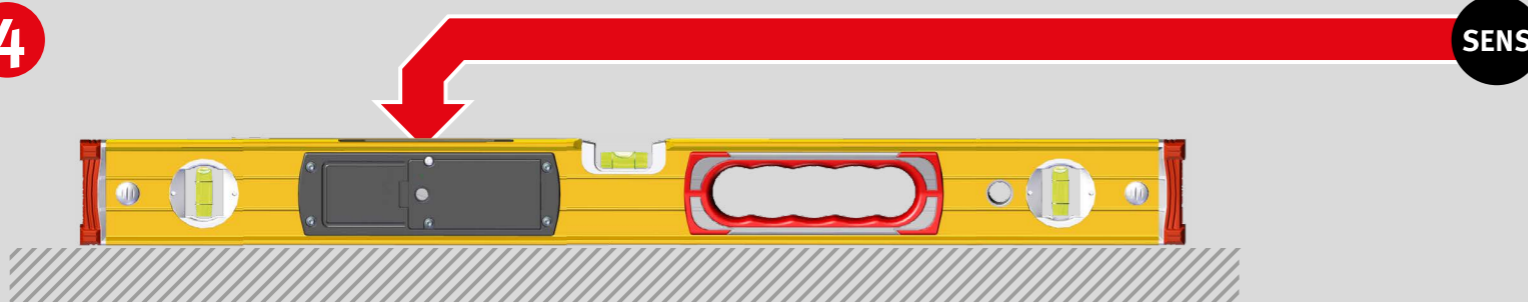

8. Technical data

Accuracy:

Electronic module

0° + 90° : ± 0.05°
In intermediate areas: ± 0.1°

Spirit level

in normal position: 0.5 mm/m = 0.029°

in reverse position: 0.5 mm/m = 0.029°

Batteries : 2 x 1.5 V alkaline, mignon, AA, LR6, MN1500

Battery life:

without display lighting ≥ 400 hours

with maximum display lighting ≤ 80 hours

Operating temperature range: -10 °C to +50 °C / 14 °F to 122 °F

Storage temperature range: -20 °C to +65 °C / -4 °F to 149 °F

Protection class: IP 67

Subject to technical modifications.

STABILA Messgeräte

Gustav Ullrich GmbH

Landauer Str. 45 / D-76855 Annweiler

☎ + 49 63 46 309 - 0

✉ info@de.stabila.com